



Product Specification

Product Name: 24V50A Lithium Battery management system

Product Number: 2450-1003-10B

Configuration	Parameter	Function
Single voltage platform	3.7V	
PCS	14S	Options
Capacity	75AH	Settable
External switch	ON	Options
Current limiting	ON	Options
LCD	ON	Options
Storage	ON	Own
Heating	ON	Options
Precharge	ON	Own
Communication	RS232、RS485	Options

Signature and seal of supplier			Signature and seal of client		
Executed By	Lin Jialei	Checked By	Wei Qi	Approved By	Huang Bin



Date		Date		Date	
<p>上海恩阶电子科技有限公司</p>					



目录

1. Application scope.....	错误! 未定义书签。
2. Normative citation documents.....	错误! 未定义书签。
3. Functional characteristics.....	错误! 未定义书签。
3.1. Battery voltage detection.....	错误! 未定义书签。
3.2. Cell, environment and power temperature detection.....	错误! 未定义书签。
3.3. Battery charge/discharge current detection.....	错误! 未定义书签。
3.4. Short circuit protection function.....	错误! 未定义书签。
3.5. Battery capacity and cycle times.....	错误! 未定义书签。
3.6. Charge, Discharge MOSFET switch.....	错误! 未定义书签。
3.7. Balance of intelligent single cell.....	错误! 未定义书签。
3.8. LED indication function.....	错误! 未定义书签。
3.9. Dormant function.....	错误! 未定义书签。
3.10. One-key switch machine.....	错误! 未定义书签。
3.11. CAN and RS485 communication interfaces.....	错误! 未定义书签。
3.12. Communications.....	错误! 未定义书签。
3.13. Historical data records are stored and read.....	错误! 未定义书签。
3.14. Battery Management Parameters.....	错误! 未定义书签。
3.15. Battery management functions.....	错误! 未定义书签。
3.16. Precharge function.....	错误! 未定义书签。
3.17. Connect the compensation.....	错误! 未定义书签。
3.18. Charging current limit.....	错误! 未定义书签。
3.19. PC.....	错误! 未定义书签。
3.20. Program upgrades.....	错误! 未定义书签。
4. Functional framework.....	错误! 未定义书签。
5. Electrical characteristics.....	错误! 未定义书签。
6. Basic parameters.....	错误! 未定义书签。
6.1. Basic parameters.....	错误! 未定义书签。
6.2. Basic mode of work.....	错误! 未定义书签。
6.3. LED light indication instructions.....	错误! 未定义书签。
7. Functional description.....	错误! 未定义书签。
7.1. Standby state.....	错误! 未定义书签。
7.2. Over-protection and rehabilitation.....	错误! 未定义书签。
7.3. Protection and rehabilitation.....	错误! 未定义书签。
7.4. Charging overcurrent protection and recovery.....	错误! 未定义书签。
7.5. Discharge overcurrent protection and recovery.....	错误! 未定义书签。
7.6. Temperature protection and recovery.....	错误! 未定义书签。
7.7. Balanced function.....	错误! 未定义书签。
7.8. Turn on and off.....	错误! 未定义书签。
7.9. Storage functions.....	错误! 未定义书签。
8. Dimensional mapping.....	错误! 未定义书签。



9. Reference diagram and connection instructions	错误！未定义书签。
9.1. Wiring definition	错误！未定义书签。
9.2. Order of up and down	错误！未定义书签。
10. Communications	错误！未定义书签。
10.1. CAN communications	错误！未定义书签。
10.2. RS485 communications	错误！未定义书签。
10.3. parallel communication	错误！未定义书签。
10.4. Dial code address selection	错误！未定义书签。
11. LCD Screen	错误！未定义书签。
12. Points for attention	错误！未定义书签。

上海恩阶电子科技有限公司



1、 Application scope

This product is a fully functional 8 series lithium ion battery pack management system, with monomer overvoltage / undervoltage, total voltage undervoltage / overvoltage, charge / discharge overcurrent, high temperature, low temperature and short circuit protection and recovery functions. to achieve accurate measurement of SOC during charge and discharge, SOH health status statistics. realize voltage equalization during charging. Data communication is carried out with the host computer through RS485 communication, and the parameter configuration and data monitoring are carried out through the human-computer interaction of the upper computer software.

Note: The baud rate of the host computer is 9600

2、 Normative citation documents

The following documents are essential for the application of this document. The date-only version of the reference file is applicable to this file. The latest version of any undated reference file (including all modifications) applies to this file.

GB/T 191	Marking of Packaging Storage and Transportation
GB/T 2408-2008	plastic Determination of combustion properties Horizontal and vertical test
YD/T 983-2013	Electromagnetic Compatibility Limit and Measurement Method for Communication Power Equipment
GB/T 17626.5-2008	Electromagnetic compatibility test and surge (shock) immunity test for measuring technology
GB/T 17626.2-2006	Electromagnetic Compatibility Test and Measurement Technology
YD/T 2344.1—2011	Lithium iron phosphate battery pack for communications - Part 1: integrated battery pack
YD/T 2344.2—2015	Lithium iron phosphate battery pack for communications - Part 2: discrete batteries
YD/T 1363.3	Communications Bureau (Station) Power, Air Conditioning and Environmental Centralized Monitoring Management System Part 3:Front-end Intelligent Equipment Protocol
YD/T 1058-2015	High Frequency Switching Power Supply System for Communication



3、 Functional characteristics

3.1、 Battery voltage detection

Real-time acquisition and monitoring of the voltage of the series cell to realize the alarm and protection of overvoltage and undervoltage. The voltage detection accuracy of the cell is $\pm 10\text{mV}$ at $0 \sim 45^\circ\text{C}$ and $\pm 30\text{mV}$ at $-20 \sim 70^\circ\text{C}$.

Alarm, protection parameter setting can be changed by the upper computer.

3.2. Cell, environment and power temperature detection

The BMS measure the cell temperature, ambient temperature and power temperature in real-time via NTC to provide high temperature or low temperature warnings and protections. The measured temperature difference is within $\pm 2^\circ\text{C}$

Cell temperature sensor USES 10K, B value 3435.

Alarm, protection parameter setting can be changed by the upper computer.

3.3. Battery charge/discharge current detection

The charge and discharge current of the battery pack is collected and monitored in real time by detecting the resistance of the current connected in the charge and discharge main circuit, The current accuracy is better than $\pm 1\%$.

Alarm, protection parameter setting can be changed by the upper computer.

3.4. Short circuit protection function

Has the function of detecting and protecting the output short circuit.

3.5. Battery capacity and cycle times

Real-time calculation of battery residual capacity, complete the learning of total charging and discharging capacity at one time, SOC estimation accuracy is better than $\pm 5\%$. It has the function of counting the number of charge and discharge cycles. When the accumulative discharge capacity of the battery pack reaches 80% of the set full capacity, the number of cycles will increase once.

Alarm, protection parameter setting can be changed by the upper computer.

3.6. Charge, Discharge MOSFET switch

Low internal resistance, high current, high capacitance for backup power applications load startup, zero switching, double charging voltage optimization design.

3.7. Balance of intelligent single cell

Unbalanced cells can be balanced when charging or standby, which can effectively improve the service time and cycle life of the battery.

Equalizing open voltage and equalizing differential pressure can be set by upper computer.



3.8. LED indication function

There are 6 LED indicators, 4 white LED indicators for the current battery SOC, 1 red LED indicator for alarm and protection failure, and 1 white LED indicator for battery standby, charging and discharging state.

3.9. Dormant function

BMS has manual and automatic sleep functions;

Automatic sleep function: The battery will automatically sleep for 48 hours when there is no external charging or discharging. When the battery pack is over-discharged, the communication is maintained for 1 minute, and the BMS enters the dormant state.

Manual sleep function: 1. By manually pressing the 6S reset button, the BMS enters sleep after the 6 LED lights light up in sequence.

2. The switch is controlled by an external switch, the switch is turned on when the switch is closed, and the switch is turned off when the switch is off.

The standby and hibernation can be set through the host computer.

3.10. One-key switch machine

BMS in parallel, the host can control the slave machine and boot. The host must dial the code according to the parallel mode, the host dial code address can not achieve one-click switch machine. (The batteries return to each other during the machine and can not be shut down by one button)

3.11. Communications

1. Connect the upper computer through RS485 set
2. After the RS485 set is connected, the host CAN/RM485 interface is connected to the inverter

3.12. Historical data records are stored and read

Historical data is to store a piece of data according to the BMS state transition; to store all kinds of alarm, protection trigger and elimination measurement data in real time; to store the measurement data in a certain time period by setting the record start time, record end time and record interval time. Currently can store not less than 300 historical data records, through the PC to read historical data and save as excel files into the computer.

3.13. Historical data records are stored and read

Historical data is to store a piece of data according to the BMS state transition; to store all kinds of alarm, protection trigger and elimination measurement data in real time; to store the measurement data in a certain time period by setting the record start time, record end time and record interval time. Currently can store not less than 300 historical data records, through the PC to read historical data and save as excel files into the computer.



3.14、Battery management functions

Voltage related functions, temperature related functions, current related functions (**Note: The output short-circuit function does not support the shutdown setting**), capacity related functions can be turned on or off through the upper computer setting.

3.15、Precharge function

The precharge function can be started immediately after starting up or discharging tube is turned on. The precharge time can be set (1mS to 5000mS) to cope with various capacity load scenarios and avoid short circuit protection of BMS output.

3.16、Connect the compensation

To prevent excessive pressure difference between cells or modules, 2 compensation points can be provided. When a wire or a long copper bar is used between the cells, a voltage difference will be generated, and impedance compensation is required. You can check whether the voltage difference between the cells is too large through the host computer.

When discharging, measure the pressure difference between the wire and the long copper bar; if the pressure difference is too large, according to the pressure difference/current=impedance, manually fill in the calculated impedance into the upper computer parameters. In the upper computer parameters, the default is the compensation impedance of the 9th and 13th wire connection, and the 2-way compensation impedance can be set according to the actual battery cell module.

Note: If the battery cell module is assembled with long wires and long copper bars, it must be communicated with the BMS manufacturer for impedance compensation. Otherwise it will affect the battery consistency.

3.17、Charging current limit

Charging current limiter can be divided into two modes: active current limiter and passive current limiter. (**Note: Customers choose passive current limiting**)

1. Active current limiting: In the charging state of BMS, BMS keeps the current limiting module MOS tube open and actively restricts the charging current to 10A.

2. Passive current limiting: In the charging state of BMS, BMS opens the charging module MOS tube. If the charging current reaches the overcurrent warning value of charging (**Note: current setting 100A**), open the current limiting module MOS tube 10A, and re-test whether the charger current reaches the passive current limiting condition after 5 minutes of current limiting. (The passive current limit value can be set on)

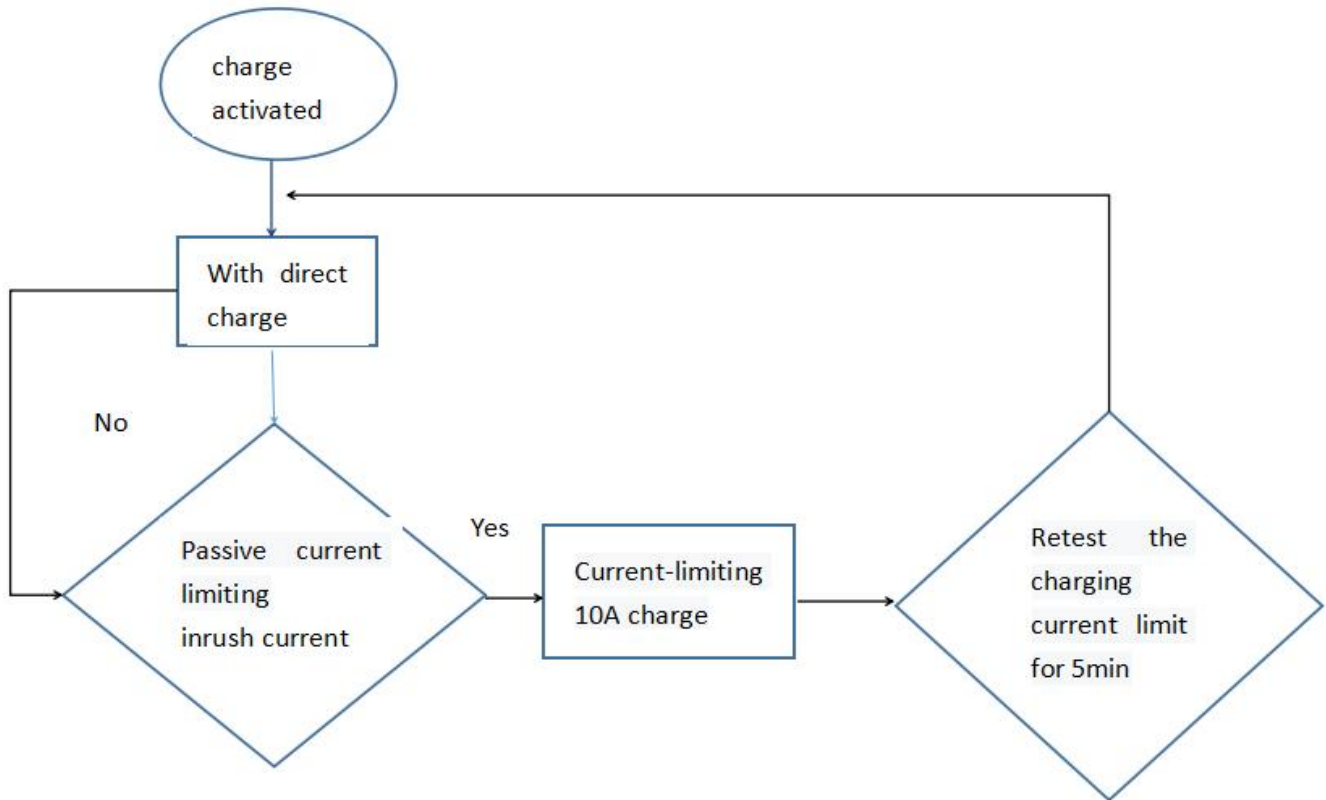

3.18、PC

The host computer uses BatteryMonitorV2.1.9. It can switch between English and Chinese (English protocol is loaded when switching to English) and the loading protocol (Chinese file name: 16S_V20_ADDR, English protocol name: 16S_V20_ADDR_EN). Please check the operation method in the file of host computer for the operation instructions.

3.19、Program upgrades

The main program version can be upgraded through the firmware update in the upper computer software.

The upper computer and the BMS are connected via RS485.

4、功能框架图

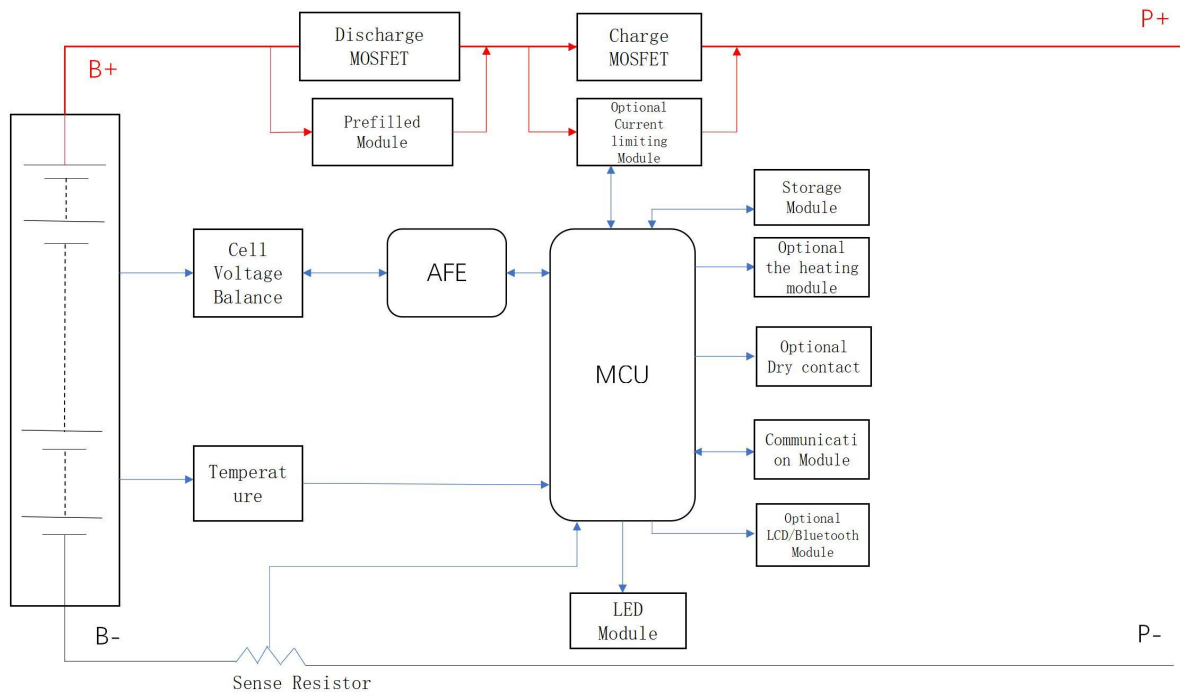

5、电气特性

Project	Min	Max	Type	Unit
Normal operating voltage	21.6	29.2	24	V
Normal charging voltage	/	30	28	V
Operating temperature range	-20	70	25	°C
Storage temperature	-40	85	25	°C
Use environment humidity	10	85	/	%
Continuous charging current	/	60	50	A
Continuous discharge current	/	60	50	A
Discharge output resistance	<2			mΩ
Normal operating power	<40			mA
Dormancy power consumption		50	0	uA



6、基本参数

6.1、基本参数设置

Function name	Function settings	Item list	Set value	Setting range
Single voltage alarm	Open	Single high pressure alarm	4150mV	Can be set
		High pressure recovery of monomer	4000mV	Can be set
	Open	Single low voltage alarm	3100mV	Can be set
		Low pressure recovery of monomer	3300mV	Can be set
Monomer overweight protection	Open	Monomer overweight protection	4200mV	Can be set
		Recovery of monomeric overpressure	4000mV	Can be set
		Overpressure recovery conditions	1.monomer voltage drop overvoltage recovery point 2.residual capacity below intermittent recharge capacity 96% Note: Two conditions must be met to recover It is detected that the battery has a discharge current $\geq 3A$	
Monomer underpressure protection	Open	Under voltage protection voltage	4200mV	Can be set
		Under voltage recovery voltage	4000mV	Can be set
		Single under pressure shutdown	Shut down after undervoltage protection and maintain 1 minute communication	
		Under pressure recovery conditions	Charging current detected $>1 A$	



Battery Total Pressure Alarm Battery Total Pressure Alarm	Open	Total pressure high pressure alarm	57.4V	Can be set
		Total pressure recovery	56.0V	Can be set
	Open Open	Total Pressure Low Pressure Alarm	43.4V	Can be set
		Total pressure high pressure alarm	46.0V	Can be set
Total pressure overvoltage protection	Open	Total pressure overvoltage protection	58.0V	Can be set
		Total pressure relief	56.0V	Can be set
	Open	Overpressure recovery conditions	1.monomer voltage drop overvoltage recovery point 2.residual capacity below intermittent recharge capacity 96%	
			Note: Two conditions must be met to recover It is detected that the battery has a discharge current > 3A	
Total pressure underpressure protection	Open	Total pressure underpressure protection	40.6V	Can be set
		Total underpressure recovery	56.0V	Can be set
	Open	Total undervoltage shutdown	Shut down after undervoltage protection and maintain 1 minute communication	
		Underpressure recovery conditions	Charging current detected >1A	
Cell	Open	Charge High Temperature Alarm	50°C	Can be set



temperature forbidden to charge		Charging High Temperature Recovery	47°C	Can be set
		Overcharge protection	55°C	Can be set
		Overcharge recovery	50°C	Can be set
		Charge Low Temperature Alarm	2°C	Can be set
		Low temperature charging recovery	5°C	Can be set
		Undercharge protection	-10°C	Can be set
		Recovery of undercharging	0°C	Can be set
Cell temperature forbidden to discharge	Open	High Temperature Discharge Alarm	52°C	Can be set
		High temperature discharge recovery	47°C	Can be set
		Discharge overtemperature protection	55°C	Can be set
		Discharge overtemperature recovery	50°C	Can be set
		Low temperature discharge alarm	-10°C	Can be set
		Low temperature discharge recovery	3°C	Can be set
		Discharge undertemperature protection	-15°C	Can be set



		Discharge undertemperature recovery	0°C	Can be set
Environmental temperature protection	Open	Environmental High Temperature Alarm	50°C	Can be set
		Environmental High Temperature Recovery	47°C	Can be set
		Environmental Over-temperature Protection	60°C	Can be set
		Environmental Overheating Recovery	55°C	Can be set
		Environmental Low Temperature Warning	0°C	Can be set
		Environmental Low Temperature Recovery	3°C	Can be set
		Environmental under-temperature protection	-10°C	Can be set
		Environmental undertemperature recovery	0°C	Can be set
		Power temperature protection	Open	Power High Temperature Alarm
Power High Temperature Recovery	85°C			Can be set
Overpower protection	100°C			Can be set



		Power overtemperature recovery	85°C	Can be set
Charging Current Limit	Closed	Active Current	10A	Charger current greater than 10A, opening limit
	Open	Passive limit flow		Charger current is greater than charging overcurrent alarm (value can be set), start current limit
		Charge Limit Delay	5 minutes	After the current limit is switched on, check again 5 minutes later whether the current limit is switched on or not
Charge Overcurrent Alarm	Open	Charge Overcurrent Alarm	70A	Can be set
		Charging Overcurrent Recovery	65A	Can be set
Charging Overcurrent Protection	Open	Charging Overcurrent Protection	80A	Can be set
		Charge Overcurrent Delay	10S	Can be set
		Overcurrent recovery conditions	Discharge recovered immediately or automatically after 60 S	
Effective charging current	Charge into current		600mA	
	Charge Exit Current		500mA	
Discharge Overflow Warning	Open	Discharge Overflow Warning	-77A	Can be set
		Discharge overcurrent recovery	-75A	Can be set



Discharge over-current protection	Open	Discharge over-current protection	-80A	Can be set
		Discharge Overcurrent Delay	10S	Can be set
		Overcurrent recovery conditions	Charge immediately, or after 60 S automatically	
Transient Overcurrent Protection	Open	Transient Overcurrent Protection	-150A	Can be set
		Transient Overcurrent Delay	30mS	Can be set
		Transient Overcurrent Recovery	Charge immediately, or after 60 S automatically	
	Closed	Transient Overcurrent Lock	Continuous secondary overcurrent, exceeding the number of overcurrent locks	
		Overcurrent locking times	5 times	
		Transient lockout	Connect charger	
Output short circuit	Open	Short circuit protection current and delay	Write program (Note: Cannot be set)	
		Recovery of short circuit protection	Charge immediately, or after 60 S automatically	
	Open	Short circuit protection lock	Continuous output short circuit, over-current lock times	
		Short circuit locking times	5 times	
		Short circuit lock release	Connect charger	
Effective	Discharge into current		-500mA	



discharge current	Discharge withdrawal current	-400mA			
Core equalization function	Open	Standby balance	Uncharged/discharge state open equilibrium		
		Standby equalization time	10 hours		
	Open	Charge Balance	Open equalization in charging state and floating state		
	On voltage condition	Balanced on voltage	4000mV		
		Equilibrium Open Pressure	30mV		
		Equilibrium end differential pressure	20mV		
	Open	Equilibrium temperature limits	Close the temperature range evenly according to the (ambient alarm temperature)		
		Equilibrium High Temperature Ban	50°C		
		Equilibrium cryogenic prohibition	0°C		
	Core Failure Alarm	Open	Failure Pressure Differential	500mV	Can be set
Core recovery pressure differential			300mV		
Battery capacity setting	Battery rated capacity		75Ah	5Ah~300Ah	
	Battery residual capacity		Estimation of core voltage	Can be set	
	Accumulated cycle capacity		80%	Number of cycles (Set)	
	Open	Residual capacity alarm	15%		
	Open	Residual capacity protection	5%	Turn off output	



Precharge function	2000ms	0~5000ms	BMS boot up precharge function	
BMS Power Management	Open	Maximum standby time	24h (Charger is not present and no effective discharge current)	
Low temperature heating of core	Open	Low temperature heating of core	0°C	Can be set
		Core heating recovery	10°C	
		Heating on logic	The charger is on line and the temperature of the cell reaches the opening condition. Turn on and heat up.No heating in standby state and discharge state	
External switches	Open	BMS in standby state can operate external switch off and turn on BMS.		
LCD screen	Open	Simple monitoring software, can view the core,temperature, current and other data.		
Compensation impedance	Compensation point 1	0m Ω	9	Can be set
	Compensation point 2	0m Ω	13	

6.2、Basic mode of work

6.2.1.charging mode

When the BMS detects that the charger is connected and the external charging voltage is greater than the internal battery voltage by more than 0.5V, when the charging current reaches the effective charging current, it enters the charging mode.

6.2.2.discharge mode

BMS into discharge mode when the load connection is detected and the discharge current reaches the effective discharge current.

6.2.3.standby mode

When the above two modes are not satisfied, enter standby mode.

6.2.4、 shutdown mode

Normal standby for 48 hours, battery triggers under-voltage protection, key-press shutdown or



external switch shutdown, BMS enters shutdown mode.

Wake-up conditions for shutdown mode: 1. Charge activation; 2. 48V voltage activation; 3. Press the key to turn on; 4. External switch.

6.3. LED light indication instructions

6.3.1、LED lamp sequence

1 operational light ,1 alarm light ,4 capacity indicator lights



6.3.2.Capacity indication

Status		Status				Discharge			
Capacity indicator		L4 ●	L3 ●	L2 ●	L1 ●	L4 ●	L3 ●	L2 ●	L1 ●
The remaining capacity	0~25%	OFF	OFF	OFF	Flash	OFF	OFF	OFF	Solid Green
	25~50%	OFF	OFF	Flash	Solid Green	OFF	OFF	Solid Green	Solid Green
	50~75%	OFF	Flash	Solid Green	Solid Green	OFF	Solid Green	Solid Green	Solid Green
	≥75%	Flash	Solid Green	Solid Green	Solid Green	Solid Green	Solid Green	Solid Green	Solid Green
Running indicator light ●		Solid Green				Flash			

6.3.3.Light Blink explanation

Flash Mode	ON	OFF
Flash 1	0.25s	3.75s
Flash 2	0.5s	0.5s
Flash 3	0.5s	1.5s

6.3.4.State indication

System state	Running state	RUN	ALM	SOC				Note
		●	●	●	●	●	●	
Shutdown	Sleep	OFF	OFF	OFF	OFF	OFF	OFF	OFF
Standby	Normal	Flash1	OFF	OFF	OFF	OFF	OFF	Standby status
Charge	Normal	Solid Green	OFF	According to battery indicator				Highest LED flash 2
	Alarm	Solid	Flash2	According to battery indicator				Highest LED flash 2



		Green						
	overvoltage protection	Flash1	OFF	OFF	OFF	OFF	OFF	
	Temperature ,overcurrent protection	Flash1	Flash1	OFF	OFF	OFF	OFF	
Discharge	Normal	Flash3	OFF	According to battery indicator				According to battery indicator
	Alarm	Flash3	Flash3					
	Temperature ,overcurrent , short circuit protection	OFF	Solid Green	OFF	OFF	OFF	OFF	Stop discharging, forced dormancy without action after 48h when the mains is offline
	Under-voltage protection	OFF	OFF	OFF	OFF	OFF	OFF	Stopping Discharge

1. Functional description

7.1. Standby state

BMS the correct connection on the power, in no overvoltage, undervoltage, overcurrent, short circuit, over temperature, under temperature and other protection state, press the reset button to boot, BMS in standby state. BMS standby state, the running lamp flashes, and the battery can be charged and discharged.

7.2. Over-protection and rehabilitation

7.2.1. Monomer overcharge protection and recovery

If any section of the battery core is higher than the set value of the monomer overcharge protection, the BMS enters the overcharge protection state, and the charging equipment can not charge the battery.

After the monomer overvoltage protection, when the maximum monomer voltage drops below the monomer overcharge recovery value and the SOC is below 96%, the overcharge protection state is relieved. can also discharge release.

7.2.2. Total pressure overcharge protection and recovery

If the battery voltage is higher than the set value of the total voltage overcharge protection, the BMS enters the overcharge protection state, and the charging equipment can not charge the battery. If the total voltage drops below the recovery value and SOC below 96%, the overcharge protection is relieved. It can also be released Except.

7.3. Protection and rehabilitation

7.3.1. Protection and restoration of monomers

If any section of the battery core is lower than the set value of the monomer



over-discharge protection, the BMS enters the over-discharge protection state, and the load can not discharge the battery. Hold 1 minute communication after BMS shutdown.

After over-discharge protection occurs, charging the battery pack can release the over-discharge protection state. or press the reset button, BMS will boot to re- detect whether the battery pack voltage reaches the recovery value.

Note: After the BMS discharges under-voltage protection, it is shut down, and the button is activated or the charging is activated. The BMS keeps the output voltage for 1 minute for the inverter to detect the battery voltage, so it is not allowed to discharge within 1 minute.

7.3.2. Total pressure protection and recovery

When the battery voltage is lower than the total voltage over-discharge protection set value, the BMS enters the over-discharge protection state, and the load can not discharge the battery. Hold 1 minute communication after BMS shutdown.

After over-discharge protection occurs, charging the battery pack can release the over-discharge protection state. or press the reset button, BMS will boot to re- detect whether the battery pack voltage reaches the recovery value.

Note: After the BMS discharges under-voltage protection, it is shut down, and the button is activated or the charging is activated. The BMS keeps the output voltage for 1 minute for the inverter to detect the battery voltage, so it is not allowed to discharge within 1 minute.

7.4. Charging overcurrent protection and recovery

Charging overcurrent protection can be triggered when there is no charging current limiting function. when the charging current exceeds the charging overcurrent protection setting value and reaches the delay time. BMS access charging overcurrent protection, charging equipment can not charge the battery.

After charging overcurrent protection occurs, the BMS automatically delays recovery and re-detects the external charger current. discharge can also remove the charging overcurrent protection.

7.5. Discharge overcurrent protection and recovery

When the discharge current exceeds the discharge overcurrent protection setting value and reaches the delay time. BMS into the discharge overcurrent protection, the load can not charge the battery.

After the discharge overcurrent protection occurs, the BMS automatically delays recovery and re-detects the external load current. charging can also release the discharge overcurrent protection.

Discharge over-current protection has two-stage protection to achieve transient over-current protection and discharge over-current protection recovery. Transient protection occurs when the number of times the condition will be locked, recovery must be turned off in the boot or charge release.

7.6. Temperature protection and recovery



BMS there are 6 temperature detection ports, the implementation of monitoring temperature changes to achieve protection measures.

7.6.1. Charge/discharge high temperature protection and recovery

When charging and discharging state ,4 cores NTC arbitrarily one higher than the high temperature protection set value, BMS into the high temperature protection. BMS stop charging or discharging.

If the temperature of the core is lower than the high temperature recovery value, the charge or discharge BMS resume.

7.6.2. Charge/discharge low temperature protection and recovery

When charging and discharging state ,4 cores NTC randomly one lower than the low temperature protection set value, BMS into the low temperature protection. BMS stop charging or discharging.

If the core temperature is higher than the low temperature recovery value, the charge or discharge BMS resume.

7.6.3. Ambient temperature protection, power temperature protection

When the NTC detects that the ambient temperature is higher than the ambient high temperature setting value, the BMS enters the ambient high temperature protection. The BMS stops charging and discharging.

When NTC detects that the power temperature is higher than the power protection setting value, the BMS enters the power high temperature protection. The BMS stops charging and discharging.

7.7. Balanced function

BMS should have standby and charge equalization function, the system adopts energy consumption type equalization circuit, the equalization open voltage software is adjustable, the equalization open condition any section is higher than the equalization open voltage and the pressure difference reaches the condition together.

When stop charging or the core pressure difference is less than the set value.

7.8. Turn on and off

Serial number	Function	Definition
1	Boot/boot	BMS in hibernation, press the reset button, the BMS is activated, After the LED indicator lights shine in turn, turn to normal working state.
2	Shutdown / Sleep	BMS in standby or discharge state, press this key, after 6 s, the BMS is dormant, and the LED indicator lights shine in turn, and turn to sleep state. Sleep after BMS no power consumption.
3	External	External switch can control BMS switch machine,

	switches	external switch priority
--	----------	--------------------------

7.9. Storage functions

Storage content includes: protection and alarm and its category, protection and alarm recovery time, single battery voltage, total battery voltage, charge/discharge capacity, charge/discharge current, temperature, etc.

It records in year/month/day/hour/minute/second, and can also be set to record the information content within a certain period of time.

The amount of information storage is not less than 300.

The historical data can be read through the host computer and saved as an excel file to the computer.

8、 Dimensional mapping

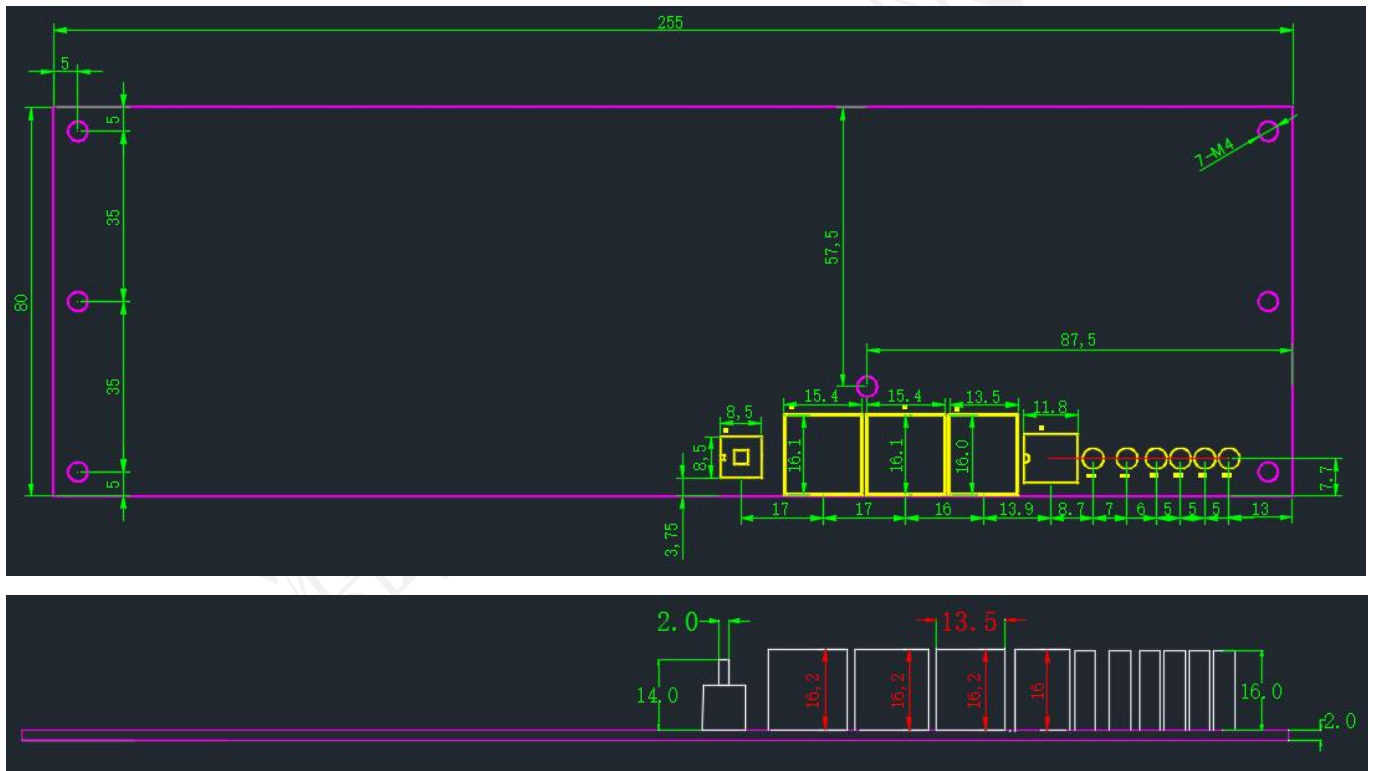

1. 9、 Reference diagram and connection instructions

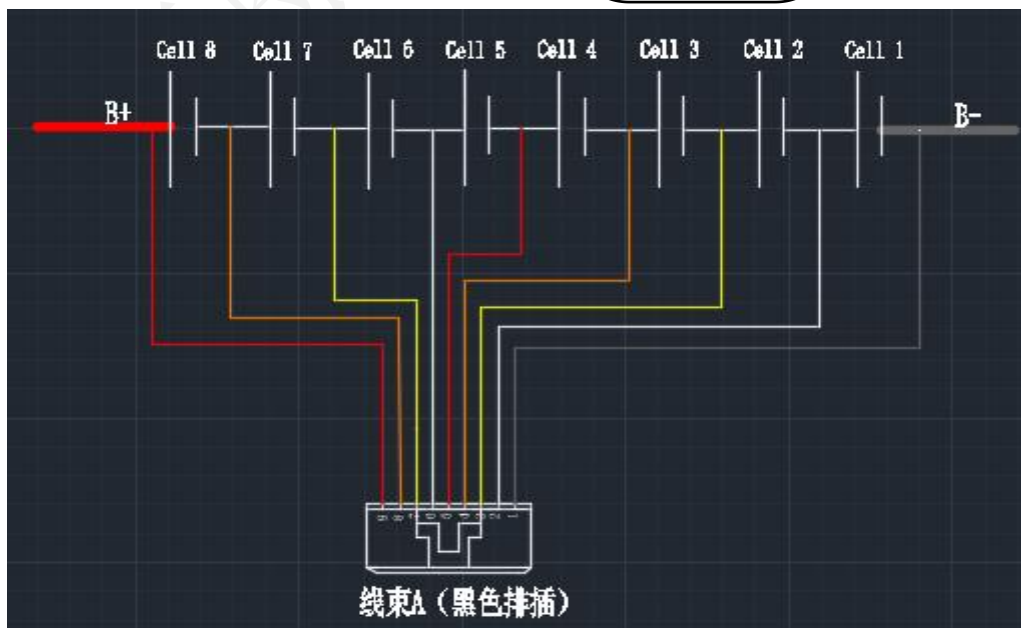
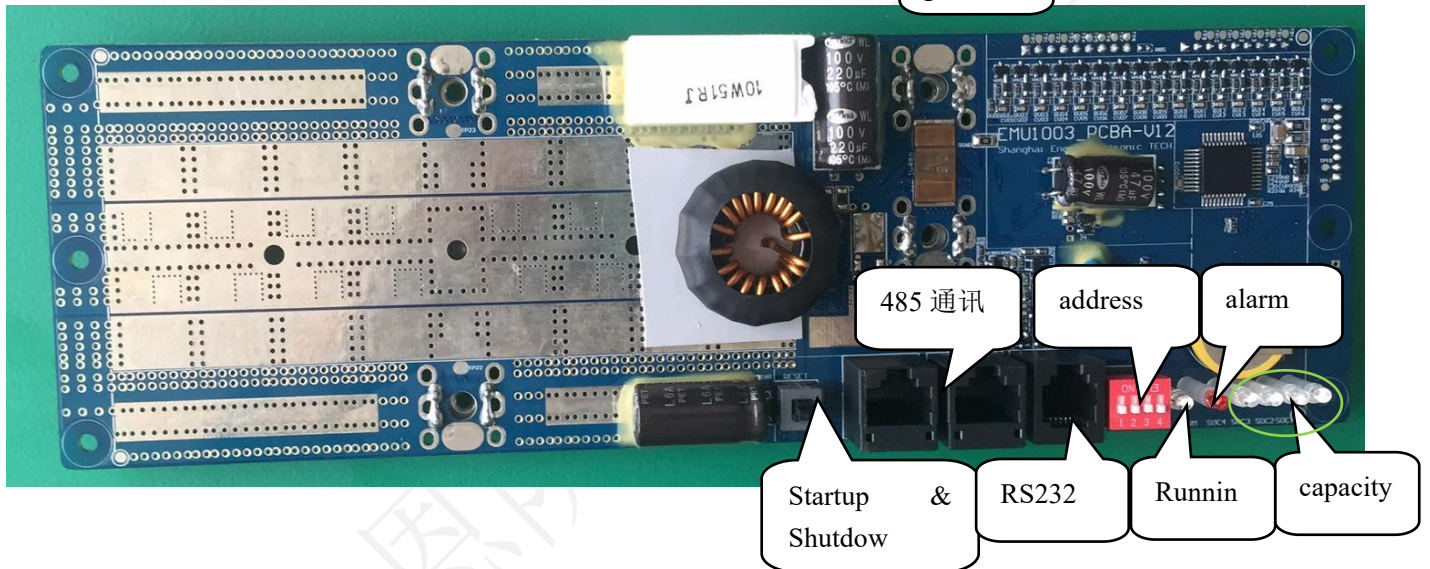
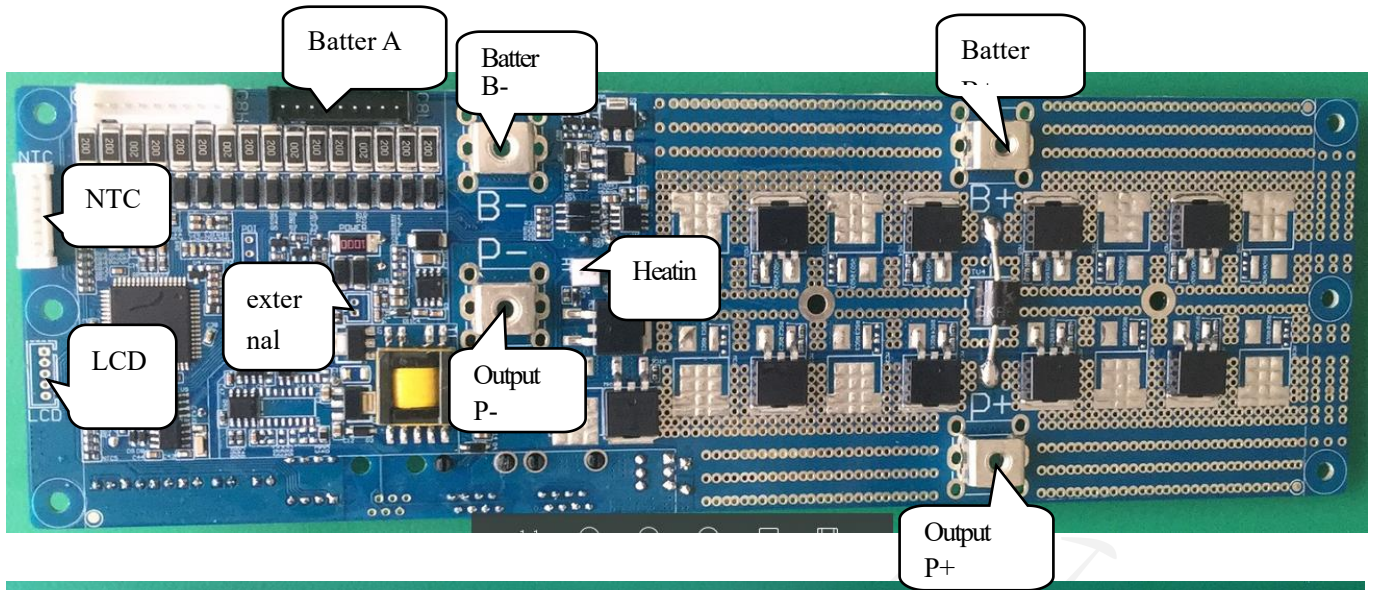

Note: There may be some differences between the actual product and the physical drawing of the above products.

9.1、接线定义

线束 A (黑色排插)		
	CELL1-	Connect to the negative of the first battery
	CELL1+	Connect to the positive pole of the first battery
	CELL2+	Connect to the positive pole of the second battery
	CELL3+	Connect to the positive pole of the third battery
	CELL4+	Connect to the positive pole of the fourth battery
	CELL5+	Connect to the positive pole of the fifth battery
	CELL6+	Connect to the positive pole of the sixth battery
	CELL7+	Connect to the positive pole of the seventh battery
	CELL8+	Connect to the positive pole of the eighth battery

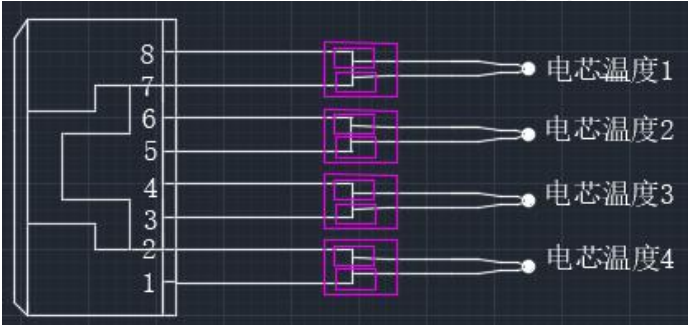
NTC 线		
	NTC1+	Connect temperature sensor NTC1
	NTC1-	Connect temperature sensor NTC1
	NTC2+	Connect temperature sensor NTC2
	NTC2-	Connect temperature sensor NTC2
	NTC3+	Connect temperature sensor NTC3
	NTC3-	Connect temperature sensor NTC3
	NTC4+	Connect temperature sensor NTC4
	NTC4-	Connect temperature sensor NTC4

注：CELL8+为电芯 B+端。

9.2、上下电顺序

1) 上电按照以下顺序：先接主板 B-，依次接排线线束 A、NTC 线，在接主板 B+，最后再连接接 P+和 P-到充电器或者负载（注：主板接好线后是关机状态，按一下复位按键开机或者闭合外部开关，充电也可激活 BMS）。

2) 下电顺序完全相反：先断开充电器或者负载（注：按 6S 复位按键或者断开外部开关，流转灯一次熄灭关机），在断开 B+，依次断开线束 A、NTC 线，最后断开 B-。

3) 输入输出

充电时：充电器的正极连接保护板的“P+”，充电器的负极连接保护板的“P-”。

放电时：负载的正极连接保护板的“P+”，负载的负极连接保护板的“P-”。

10、通信说明

10.1、RS232 communications

The BMS should have RS232 communication function for battery pack data upload, with a baud rate of 9600bps. RS232 upload communication interface. Through the RS232 communication interface, it can communicate with the host computer.

RS232 communication interface definition.

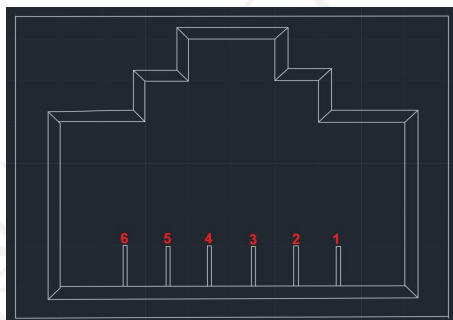

PIN	Definitions
2	GND
3	RX
4	TX
5	GND

10.2、RS485 communications

BMS has RS485 communication with battery pack integration and baud rate of 9600bps. RS485 communication interface adopts 8P8C network cable interface.

RS485 communication interface definition:

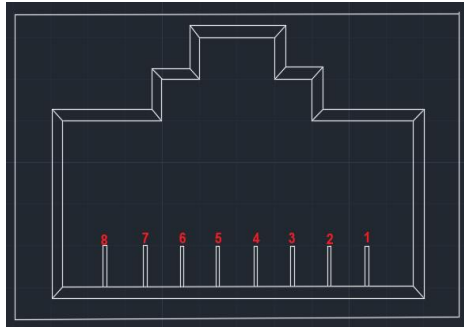

PNG	Definitions
1、8	RS485-B
2、7	RS485-A
3、6	GND
4、5	NC

10.3、Parallel communication

When multiple machines are connected in parallel, the RS485 interface is used as the parallel communication interface. The terminal device can read the sum of the battery data of all parallel packs through the 485 interface. When multiple machines are connected in parallel, the RS485 interface connection is shown in the figure below:

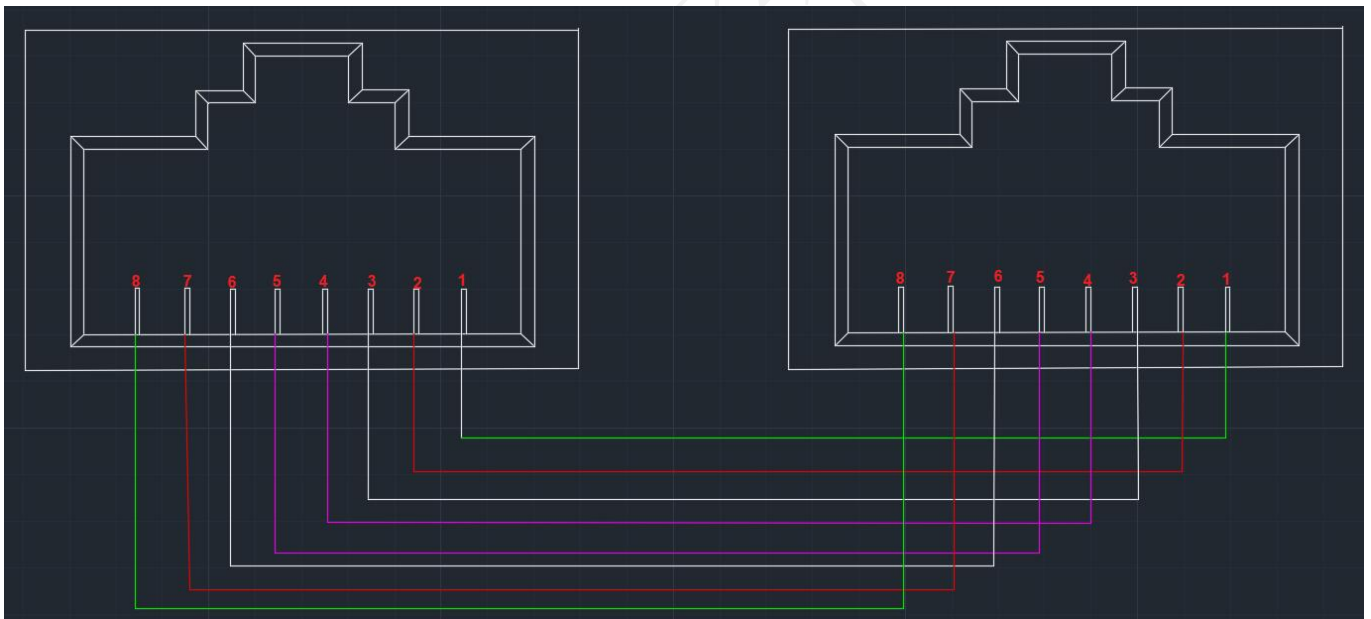

10.4、Dial address selection

Parallel DIP switch definition: In the multi-machine communication when the battery pack is connected in parallel, the DIP switch is used to distinguish different Pack addresses, and the hardware address can be set through the DIP switch on the board.

Stand-alone address setting: 0000 Connect to the host computer through RS232 or RS485

Parallel use address setting: For the definition of DIP switches, refer to the following table

For example, 2 parallel machines: the first one dials 1000 and the second dials 0100 to

connect the host computer through RS485

3 parallel machines: the first one dials 1000, the second dials 0100, and the third dials 1100 Connect to the host computer through RS485

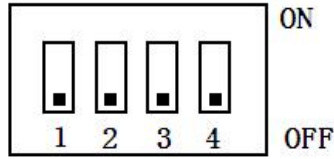

Add ress	DIP switch position				Note
	#1	#2	#3	#4	
0	OFF	OFF	OFF	OFF	Pack0
1	ON	OFF	OFF	OFF	Pack1
2	OFF	ON	OFF	OFF	Pack2
3	ON	ON	OFF	OFF	Pack3
4	OFF	OFF	ON	OFF	Pack4
5	ON	OFF	ON	OFF	Pack5
6	OFF	ON	ON	OFF	Pack6
7	ON	ON	ON	OFF	Pack7
8	OFF	OFF	OFF	ON	Pack8
9	ON	OFF	OFF	ON	Pack9
10	OFF	ON	OFF	ON	Pack10
11	ON	ON	OFF	ON	Pack11
12	OFF	OFF	ON	ON	Pack12
13	ON	OFF	ON	ON	Pack13
14	OFF	ON	ON	ON	Pack14
15	ON	ON	ON	ON	Pack15

11、LCD Screen

Please refer to the LCD screen specification for detailed instructions

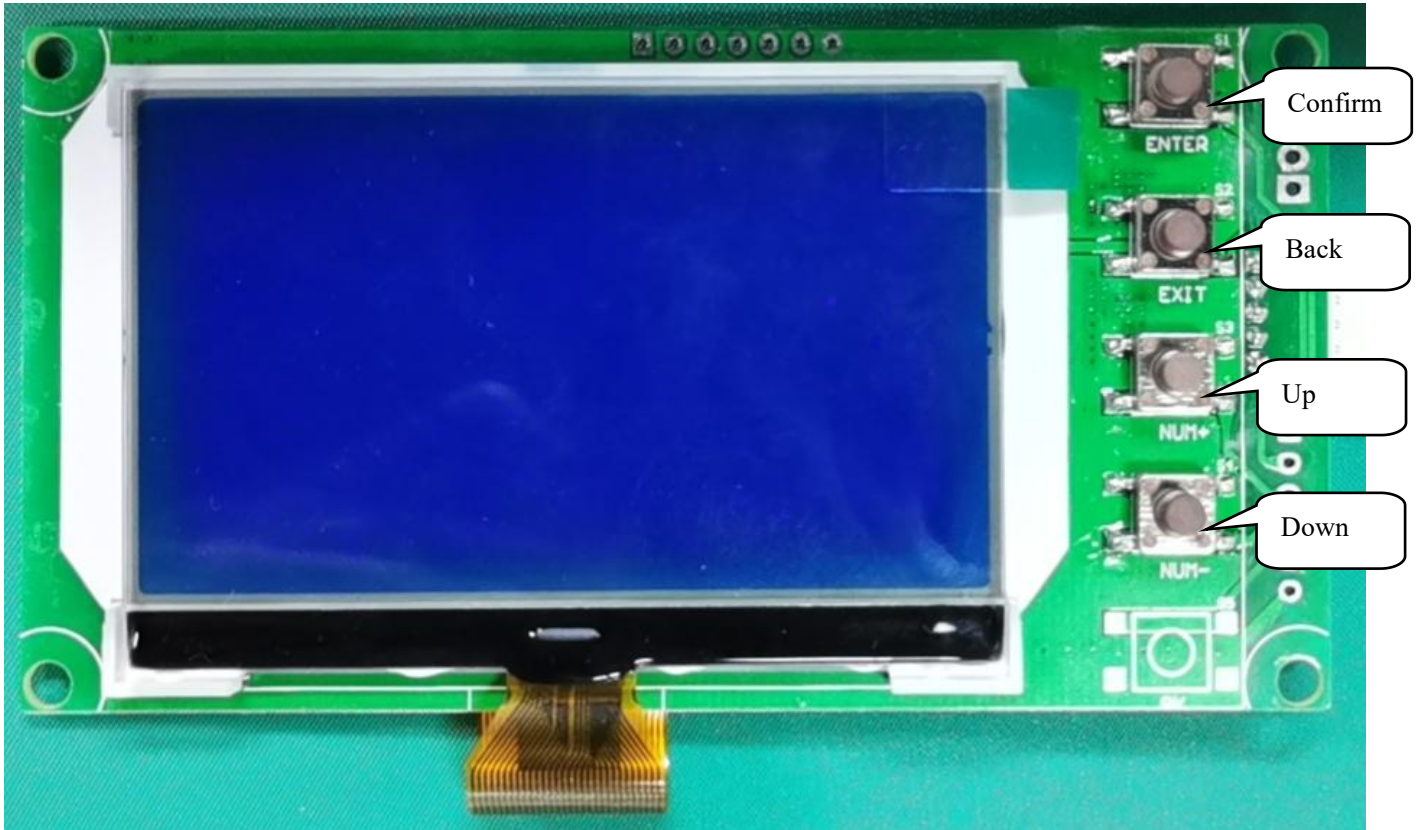

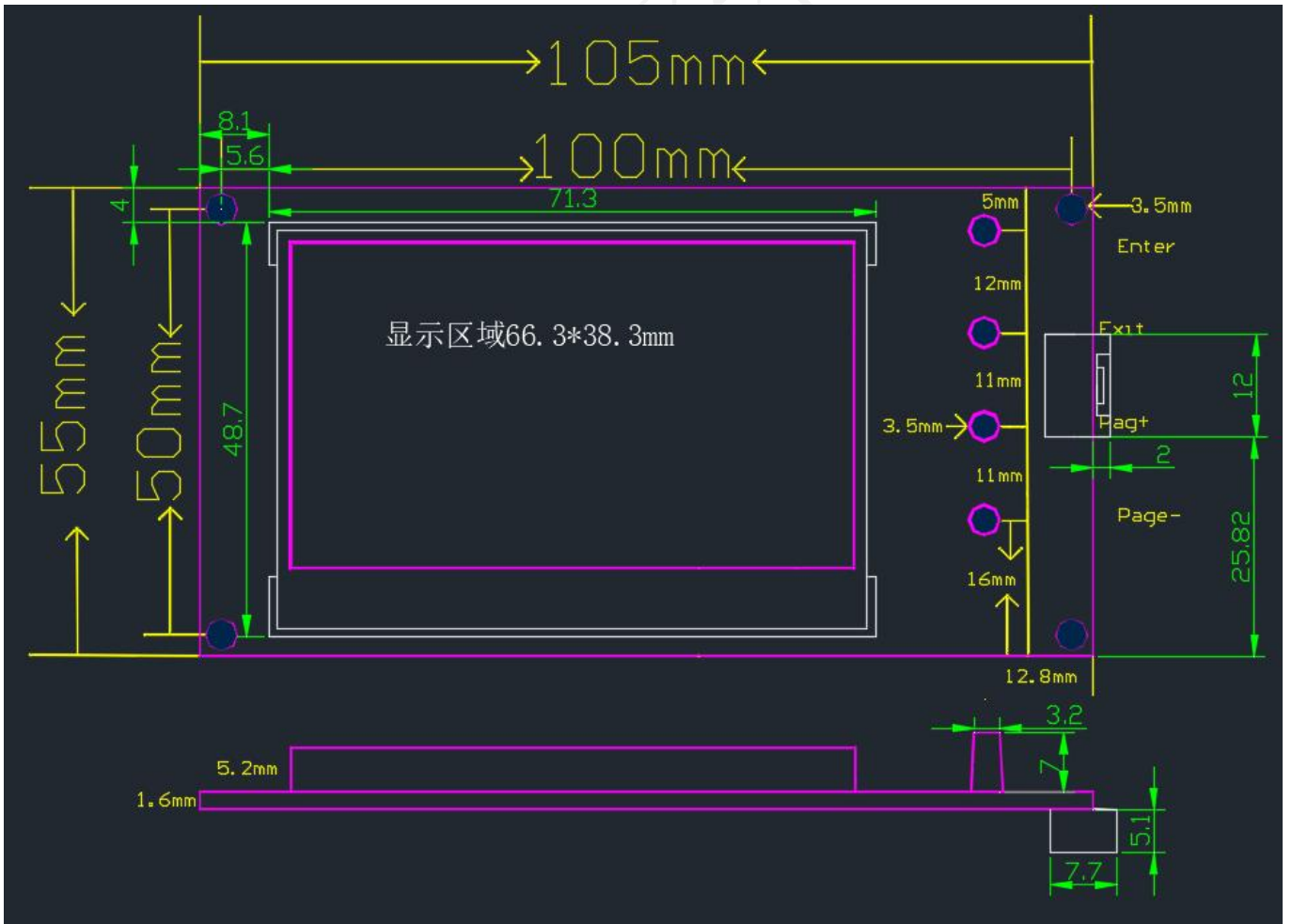
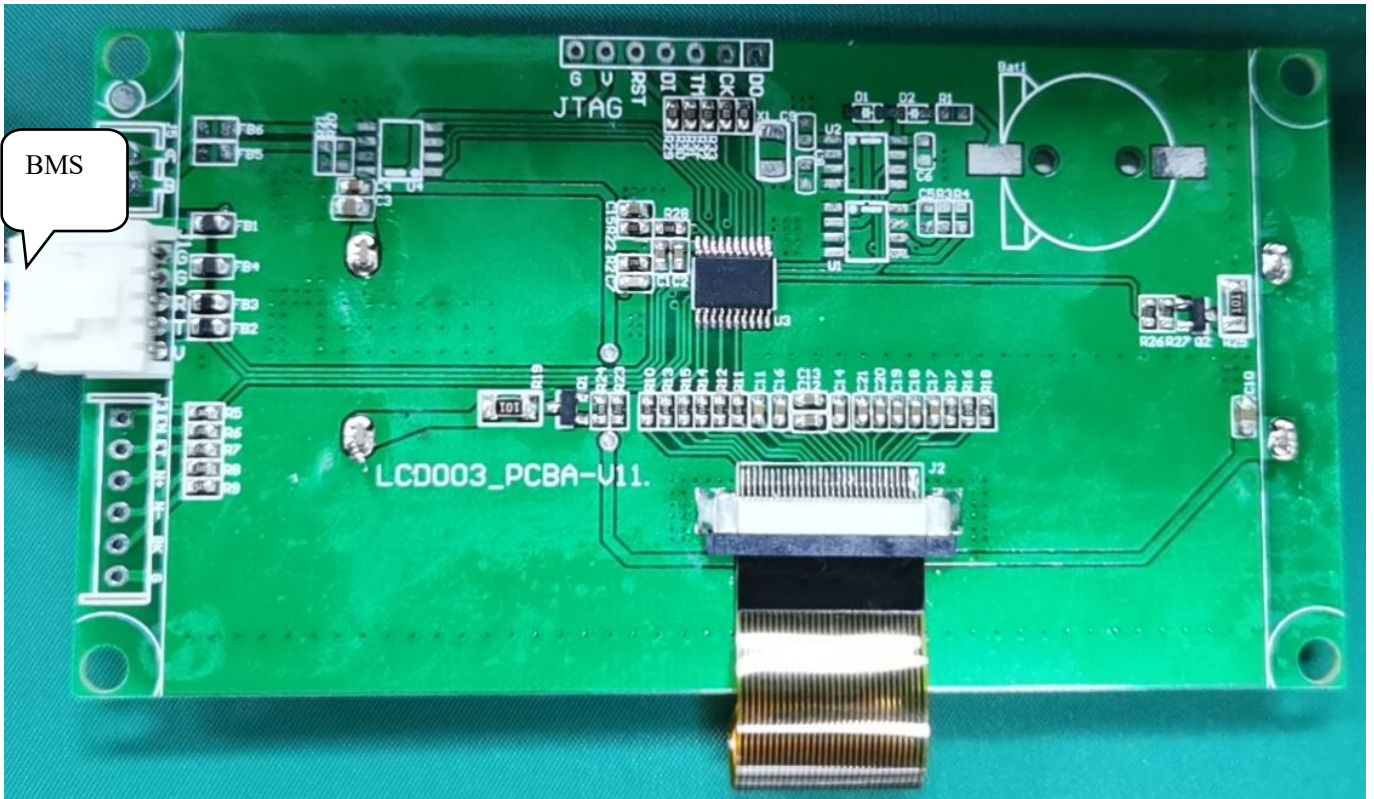



Note: The display screen is shipped according to the actual situation. Our company has three kinds of display screens LCD003 and LCD005.

上海恩阶电子科技有限公司



12、 Points for attention

- ❖ Battery management systems can not be used in series.
- ❖ BMS power components withstand voltage 100V.
- ❖ If the battery module is assembled in the form of long wire and long copper bar, it must communicate with the BMS manufacturer for impedance compensation. Otherwise, it will affect the consistency of the cell.
- ❖ The external switch on BMS is prohibited to connect with other equipment. If necessary, please confirm with the technology for docking. Otherwise, BMS will not bear any responsibility for damage.
- ❖ Do not touch the surface of the core directly when assembling, so as not to damage the core. The assembly should be firm and reliable.
- ❖ In use pay attention to lead wire head, soldering iron, solder and so on do not touch the components on the circuit board, otherwise it may damage the circuit board.
- ❖ Use process should pay attention to anti-static, moisture-proof, waterproof and so on.
- ❖ Please follow the design parameters and use conditions during use, must not exceed the value in this specification, otherwise it may damage the protection board.
- ❖ After combining the battery pack and the protection plate, if you find no voltage output or charge, please check the wiring is correct.
- ❖ The final interpretation right is owned by our company.