



Product Specification

Product Name: 48V200A Lithium Battery

management system

Product Number: 48200-1101-10E

Configuration	Parameter	Function
Single voltage platform	3.2V	
PCS	16S	Options
Capacity	200AH	Settable
External switch	ON	Options
Current limiting	ON	Options
LCD	ON	Options
Bluetooth	ON	Options
Dry contact	ON	Options
Storage	ON	Own
Heating	ON	Options
Precharge	ON	Own
Communication	CAN、RS485	Options

Signature and seal of supplier			Signature and seal of client		
Executed By	Xiehuajun	Checked By	Wei Qi	Approved By	Huang Bin
Date		Date		Date	



version	Date	Draw up/amend	Version Revision Note
V1.0	2020.06.16	Lin Jialei	Create first draft
V2.0	2022.07.25	Xie Huajun	V16 new functions, functional framework modification, etc



Directory

1. Application scope.....	5
2. Normative citation documents	5
3. Functional characteristics	6
3.1. Battery voltage detection.....	6
3.2. Cell, environment and power temperature detection.....	6
3.3. Battery charge/discharge current detection.....	6
3.4. Short circuit protection function.....	6
3.5. Battery capacity and cycle times.....	6
3.6. Charge, Discharge MOSFET switch.....	6
3.7. Balance of intelligent single cell.....	6
3.8. LED indication function.....	7
3.9. Dormant function.....	7
3.10. One-key switch machine.....	7
3.11. CAN 、RM485 and RS485 communication interfaces.....	7
3.12. Communications.....	7
3.13. Historical data records are stored and read.....	7
3.14. Battery Management Parameters.....	8
3.15. Battery management functions.....	8
3.16. Precharge function.....	8
3.17. 2-way dry contact(Options)	8
3.18. Aerosol support (optional)	8
3.19. Bluetooth(Options)	8
3.20. Connect the compensation.....	9
3.21. Charging current limit.....	9
3.23. PC.....	10
3.24. Program upgrades.....	10
4. Functional framework.....	11
5. Electrical characteristics.....	11
6. Basic parameters.....	12
6.1. Basic parameters.....	12
6.2. Basic mode of work.....	18
6.3. LED light indication instructions.....	18
7. Functional description.....	20
7.1. Standby state.....	20
7.2. Over-protection and rehabilitation.....	20
7.3. Protection and rehabilitation.....	20
7.4. Charging overcurrent protection and recovery.....	21
7.5. Discharge overcurrent protection and recovery.....	21
7.6. Temperature protection and recovery.....	21
7.7. Balanced function.....	22



7.8. Turn on and off.....	22
7.9. Storage functions.....	22
8. Dimensional mapping.....	23
9. Reference diagram and connection instructions.....	23
9.1. Wiring definition.....	25
9.2. Order of up and down.....	26
10. Communications.....	27
10.1. CAN communication and RM485 communication.....	27
10.2. RS485 communications.....	27
10.3. Parallel communication.....	28
10.4. Dial code address selection.....	28
11. LCD Screen.....	32
12. Points for attention.....	35

上海恩阶电子科技有限公司



1. Application scope

This product is a fully functional 8-16 series lithium ion battery pack management system, with monomer overvoltage / undervoltage, total voltage undervoltage / overvoltage, charge / discharge overcurrent, high temperature, low temperature and short circuit protection and recovery functions. to achieve accurate measurement of SOC during charge and discharge, SOH health status statistics. realize voltage equalization during charging. Data communication is carried out with the host computer through RS485 communication, and the parameter configuration and data monitoring are carried out through the human-computer interaction of the upper computer software.

Note: The baud rate of the host computer is 19200.

2. Normative citation documents

The following documents are essential for the application of this document. The date-only version of the reference file is applicable to this file. The latest version of any undated reference file (including all modifications) applies to this file.

GB/T 191	Marking of Packaging Storage and Transportation
GB/T 2408-2008	plastic Determination of combustion properties Horizontal and vertical test
YD/T 983-2013	Electromagnetic Compatibility Limit and Measurement Method for Communication Power Equipment
GB/T 17626.5-2008	Electromagnetic compatibility test and surge (shock) immunity test for measuring technology
GB/T 17626.2-2006	Electromagnetic Compatibility Test and Measurement Technology
YD/T 2344.1-2011	Lithium iron phosphate battery pack for communications - Part 1: integrated battery pack
YD/T 2344.2-2015	Lithium iron phosphate battery pack for communications - Part 2: discrete batteries
YD/T 1363.3	Communications Bureau (Station) Power, Air Conditioning and Environmental Centralized Monitoring Management System Part 3:Front-end Intelligent Equipment Protocol
YD/T 1058-2015	High Frequency Switching Power Supply System for Communication



3. Functional characteristics

3.1. Battery voltage detection

Real-time acquisition and monitoring of the voltage of the series cell to realize the alarm and protection of overvoltage and undervoltage. The voltage detection accuracy of the cell is $\pm 10\text{mV}$ at $0 \sim 45^\circ\text{C}$ and $\pm 30\text{mV}$ at $-20 \sim 70^\circ\text{C}$.

Alarm, protection parameter setting can be changed by the upper computer.

3.2. Cell, environment and power temperature detection

The BMS measure the cell temperature, ambient temperature and power temperature in real-time via NTC to provide high temperature or low temperature warnings and protections. The measured temperature difference is within $\pm 2^\circ\text{C}$. Cell temperature sensor USES 10K, B value 3435.

Alarm, protection parameter setting can be changed by the upper computer.

3.3. Battery charge/discharge current detection

The charge and discharge current of the battery pack is collected and monitored in real time by detecting the resistance of the current connected in the charge and discharge main circuit, The current accuracy is better than $\pm 1\%$.

Alarm, protection parameter setting can be changed by the upper computer.

3.4. Short circuit protection function

Has the function of detecting and protecting the output short circuit.

3.5. Battery capacity and cycle times

Real-time calculation of battery residual capacity, complete the learning of total charging and discharging capacity at one time, SOC estimation accuracy is better than $\pm 5\%$. It has the function of counting the number of charge and discharge cycles. When the accumulative discharge capacity of the battery pack reaches 80% of the set full capacity, the number of cycles will increase once.

Alarm, protection parameter setting can be changed by the upper computer.

3.6. Charge, Discharge MOSFET switch

Low internal resistance, high current, high capacitance for backup power applications load startup, zero switching, double charging voltage optimization design.

3.7. Balance of intelligent single cell

Unbalanced cells can be balanced when charging or standby, which can effectively improve the service time and cycle life of the battery.

Equalizing open voltage and equalizing differential pressure can be set by upper computer.



3.8. LED indication function

There are 6 LED indicators, 4 white LED indicators for the current battery SOC, 1 red LED indicator for alarm and protection failure, and 1 white LED indicator for battery standby, charging and discharging state.

3.9. Dormant function

BMS has manual and automatic sleep functions;

Automatic sleep function: The battery will automatically sleep for 48 hours when there is no external charging or discharging. When the battery pack is over-discharged, the communication is maintained for 1 minute, and the BMS enters the dormant state.

Manual sleep function: 1. By manually pressing the 6S reset button, the BMS enters sleep after the 6 LED lights light up in sequence.

2. The switch is controlled by an external switch, the switch is turned on when the switch is closed, and the switch is turned off when the switch is off.

The standby and hibernation can be set through the host computer.

3.10. One-key switch machine

BMS in parallel, the host can control the slave machine and boot. The host must dial the code according to the parallel mode, the host dial code address can not achieve one-click switch machine. (The batteries return to each other during the machine and can not be shut down by one button)

3.11. CAN 、RM485 and RS485 communication interfaces

CAN communication according to each inverter protocol to do communication, can connect inverter communication. (Note: Compatibled with Pylon, Goodwe, Deye, Luxpower, TBB; and can be switched to Growatt, Victron, SMA, SOFAR, Ginlong, and Studer)

RM485 communication according to each inverter protocol to do communication, can connect inverter communication. (Note: Compatibled with Pylon, Growatt, SRNE)

PC machine or intelligent front end can realize the data monitoring, operation control and parameter setting of the battery by RS485 communication telemetry, remote signal, remote adjustment, remote control and other commands.

3.12. Communications

Can be set through RS485, through 8 dial address address setting.

Two ways to view data:

1. Connect the upper computer through RS485 set

2. After the RS485 set is connected, the host CAN/RM485 interface is connected to the inverter

3.13. Historical data records are stored and read

Historical data is to store a piece of data according to the BMS state transition; to



store all kinds of alarm, protection trigger and elimination measurement data in real time; to store the measurement data in a certain time period by setting the record start time, record end time and record interval time. Currently can store not less than 300 historical data records, through the PC to read historical data and save as excel files into the computer.

3.14. Battery Management Parameters

The battery management parameters, such as cell overvoltage, total cell voltage overvoltage, charge and discharge overcurrent, core high and low temperature, environment high and low temperature, equalization strategy, battery series number, battery capacity, etc., can be reset by the upper computer.

3.15. Battery management functions

Voltage related functions, temperature related functions, current related functions (**Note: The output short-circuit function does not support the shutdown setting**), capacity related functions can be turned on or off through the upper computer setting.

3.16. Precharge function

The precharge function can be started immediately after starting up or discharging tube is turned on. The precharge time can be set (1mS to 5000mS) to cope with various capacity load scenarios and avoid short circuit protection of BMS output.

3.17. 2-way dry contact (Options)

There 2-way alarm output dry contacts in BMS.

Channel 1: SOC alarm, temperature alarm and protection, undervoltage alarm and protection, charge and discharge overcurrent alarm and protection (no prompt for overvoltage alarm and protection).

Channel 2: temperature failure, short circuit, monomer overvoltage protection + 30 mV, cell differential voltage failure, transient overcurrent protection.

3.18. Aerosol support (optional)

Through the aerosol dry contact, the BMS generates a BMS fault alarm to remind the user to handle the abnormal battery pack in time to avoid accidents.

3.19. Bluetooth (Options)

Through the wireless connection between mobile phone Bluetooth and battery pack Bluetooth module, the functions of battery pack management and alarm information collection, query, display, configuration modification and so on are realized.

Bluetooth app can realize the following functions:

- 1、Basic information display of battery pack
- 2、Communication configuration between BMS and inverter



3、 Battery pack alarm / protection parameters and control switch configuration

4、 Support single machine and parallel machine; Support real-time switching of battery pack single machine connection

5、 Chinese and English display switching

3.20. Connect the compensation

To prevent excessive pressure difference between cells or modules, 2 compensation points can be provided. When a wire or a long copper bar is used between the cells, a voltage difference will be generated, and impedance compensation is required. You can check whether the voltage difference between the cells is too large through the host computer.

When discharging, measure the pressure difference between the wire and the long copper bar; if the pressure difference is too large, according to the pressure difference/current=impedance, manually fill in the calculated impedance into the upper computer parameters. In the upper computer parameters, the default is the compensation impedance of the 9th and 13th wire connection, and the 2-way compensation impedance can be set according to the actual battery cell module.

Note: If the battery cell module is assembled with long wires and long copper bars, it must be communicated with the BMS manufacturer for impedance compensation. Otherwise it will affect the battery consistency.

3.21. Charging current limit

Charging current limiter can be divided into two modes: active current limiter and passive current limiter. (**Note: Customers choose passive current limiting**)

1. Active current limiting: In the charging state of BMS, BMS keeps the current limiting module MOS tube open and actively restricts the charging current to 10A.

2. Passive current limiting: In the charging state of BMS, BMS opens the charging module MOS tube. If the charging current reaches the overcurrent warning value of charging (**Note: current setting 200A**), open the current limiting module MOS tube 10A, and re-test whether the charger current reaches the passive current limiting condition after 5 minutes of current limiting. (The passive current limit value can be set on)

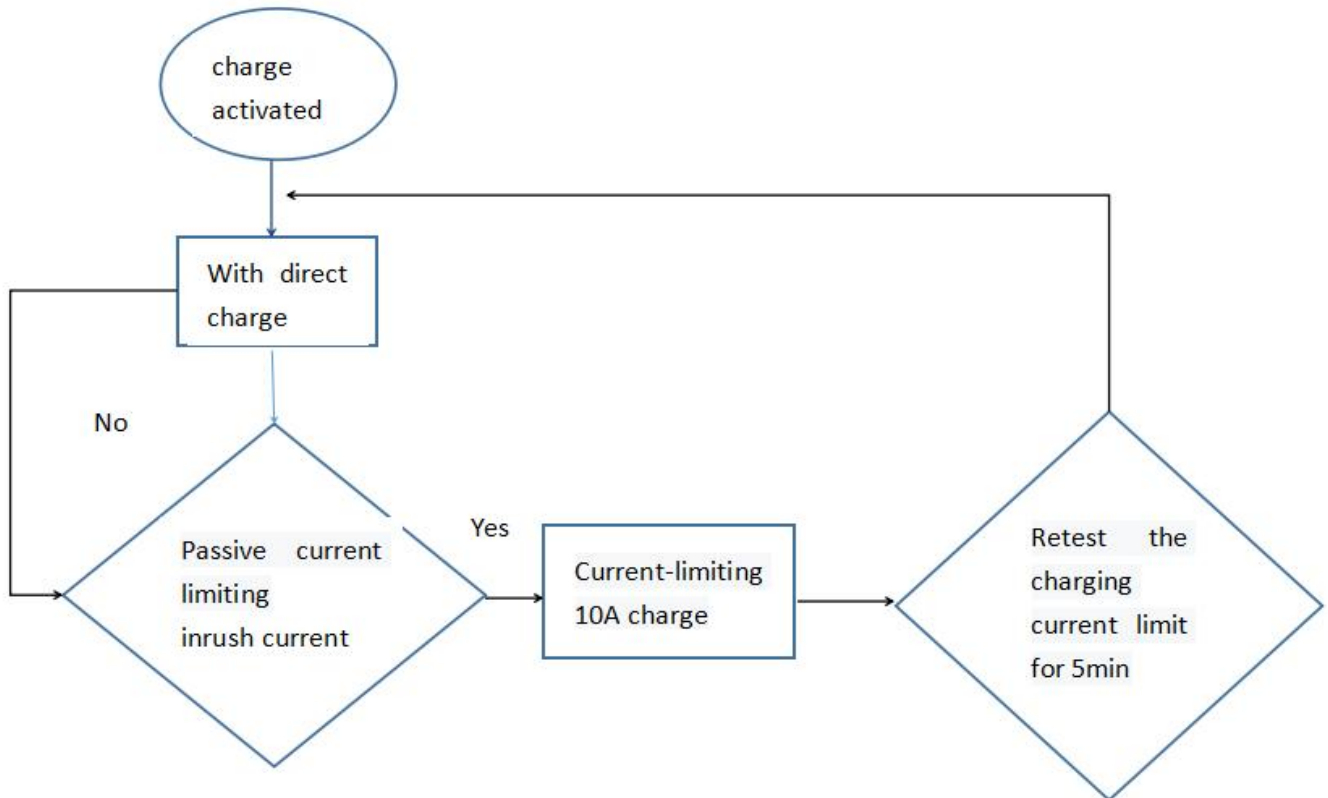

3.22. Automatic dip switch (optional)

The user can choose to enable the automatic DIP function. After the function is enabled, the parallel communication connection can be realized without manual DIP after the automatic DIP connection is connected.

3.23. PC

The host computer uses BatteryMonitorV2.1.9. It can switch between English and Chinese (English protocol is loaded when switching to English) and the loading protocol (Chinese file name: 16S_V20_ADDR, English protocol name: 16S_V20_ADDR_EN). Please check the operation method in the file of host computer for the operation instructions.

3.24. Program upgrades

The main program version can be upgraded through the firmware update in the upper computer software.

The upper computer and the BMS are connected via RS485.

4. Functional framework

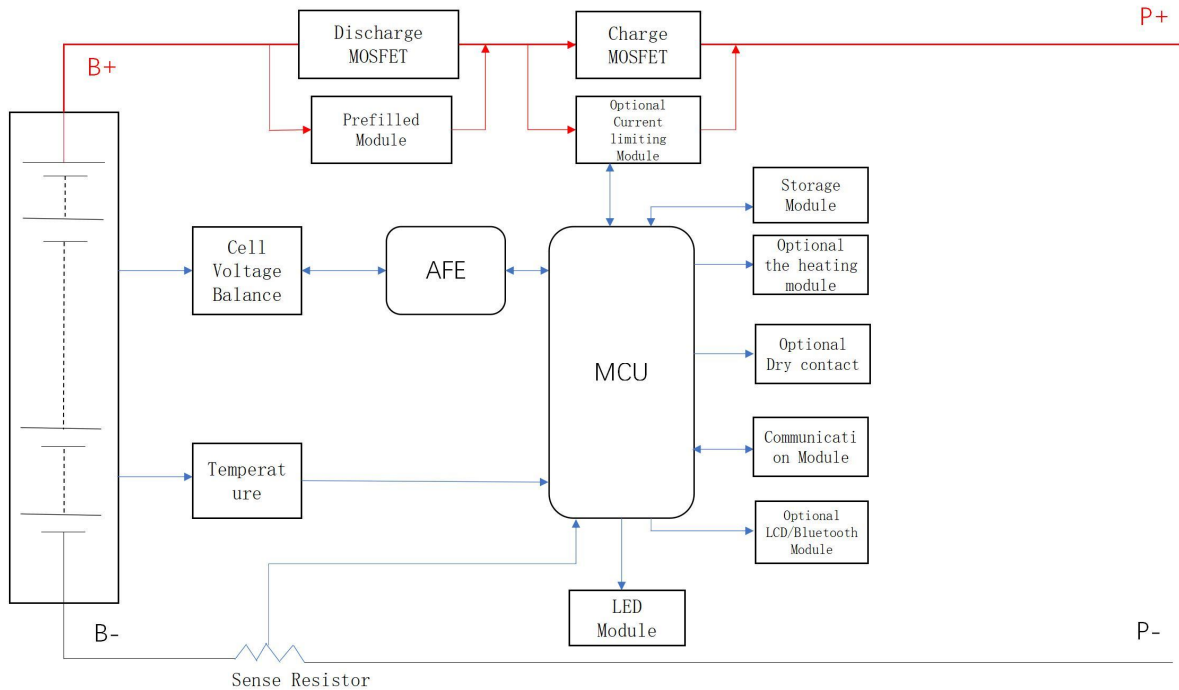

5. Electrical characteristics

Project	Min	Max	Type	Unit
Normal operating voltage	40	59	48	V
Normal charging voltage	/	60	54	V
Operating temperature range	-20	70	25	°C
Storage temperature	-40	85	25	°C
Use environment humidity	10	85	/	%
Continuous charging current	/	210	200	A
Continuous discharge current	/	210	200	A
Discharge output resistance	<2			mΩ
Normal operating power	<40			mA
Dormancy power consumption		50	0	uA

6. Basic parameters

6.1. Basic parameters

Function name	Function settings	Item list	Set value	Setting range	
Single voltage alarm	Open	Single high pressure alarm	3500mV	Can be set	
		High pressure recovery of monomer	3400mV	Can be set	
	Open	Single low voltage alarm	2900mV	Can be set	
		Low pressure recovery of monomer	3100mV	Can be set	
Monomer overweight protection	Open	Monomer overweight protection	3650mV	Can be set	
		Recovery of monomeric overpressure	3400mV	Can be set	
		Overpressure recovery conditions	1.monomer voltage drop overvoltage recovery point 2.residual capacity below intermittent recharge capacity 96% Note: Two conditions must be met to recover		
			It is detected that the battery has a discharge current > 10A		
Monomer underpressure protection	Open	Under voltage protection voltage	2700mV	Can be set	
		Under voltage recovery voltage	3100mV	Can be set	
		Single under pressure shutdown	Shut down after undervoltage protection and maintain 1 minute communication		
		Under pressure recovery conditions	Charging current detected >3 A		
Battery Total Pressure Alarm	Open	Total pressure high pressure alarm	56.0V	Can be set	
		Total pressure recovery	54.0V	Can be set	
	Open	Total Pressure Low Pressure Alarm	46.4V	Can be set	



		Total pressure and low pressure recovery	48.0V	Can be set
Total pressure overvoltage protection	Open	Total pressure overvoltage protection	57.6V	Can be set
		Total pressure relief	54.0V	Can be set
		Overpressure recovery conditions	1.monomer voltage drop overvoltage recovery point 2.residual capacity below intermittent recharge capacity 96% Note: Two conditions must be met to recover	
			It is detected that the battery has a discharge current > 10A	
Total pressure underpressure protection	Open	Total pressure underpressure protection	43.2V	Can be set
		Total underpressure recovery	48.0V	Can be set
		Total undervoltage shutdown	Shut down after undervoltage protection and maintain 1 minute communication	
		Underpressure recovery conditions	Charging current detected >3A	
Cell temperature forbidden to charge	Open	Charge High Temperature Alarm	50°C	Can be set
		Charging High Temperature Recovery	47°C	Can be set
		Overcharge protection	55°C	Can be set
		Overcharge recovery	50°C	Can be set
		Charge Low Temperature Alarm	2°C	Can be set
		Low temperature charging recovery	5°C	Can be set
		Undercharge protection	-10°C	Can be set
		Recovery of undercharging	0°C	Can be set
Cell temperature forbidden to discharge	Open	High Temperature Discharge Alarm	52°C	Can be set
		High temperature discharge recovery	47°C	Can be set



		Discharge overtemperature protection	55°C	Can be set
		Discharge overtemperature recovery	50°C	Can be set
		Low temperature discharge alarm	-10°C	Can be set
		Low temperature discharge recovery	3°C	Can be set
		Discharge undertemperature protection	-15°C	Can be set
		Discharge undertemperature recovery	0°C	Can be set
Environmental temperature protection	Open	Environmental High Temperature Alarm	50°C	Can be set
		Environmental High Temperature Recovery	47°C	Can be set
		Environmental Over-temperature Protection	60°C	Can be set
		Environmental Overheating Recovery	55°C	Can be set
		Environmental Low Temperature Warning	0°C	Can be set
		Environmental Low Temperature Recovery	3°C	Can be set
		Environmental under-temperature protection	-10°C	Can be set
		Environmental undertemperature recovery	0°C	Can be set
Power temperature protection	Open	Power High Temperature Alarm	90°C	Can be set
		Power High Temperature Recovery	85°C	Can be set
		Overpower protection	100°C	Can be set
		Power overtemperature recovery	85°C	Can be set



Charging Current Limit	Closed	Active Current	10A	Charger current greater than 10A, opening limit
	Open	Passive limit flow		Charger current is greater than charging overcurrent alarm (value can be set), start current limit
		Charge Limit Delay	5 minutes	After the current limit is switched on, check again 5 minutes later whether the current limit is switched on or not
Charge Overcurrent Alarm	Open	Charge Overcurrent Alarm	200A	Can be set
		Charging Overcurrent Recovery	195A	Can be set
Charging Overcurrent Protection	Open	Charging Overcurrent Protection	210A	Can be set
		Charge Overcurrent Delay	10S	Can be set
		Overcurrent recovery conditions	Discharge recovered immediately or automatically after 60 S	
Effective charging current	Charge into current		600mA	
	Charge Exit Current		500mA	
Discharge Overflow Warning	Open	Discharge Overflow Warning	-205A	Can be set
		Discharge overcurrent recovery	-203A	Can be set
Discharge over-current protection	Open	Discharge over-current protection	-210A	Can be set
		Discharge Overcurrent Delay	10S	Can be set
		Overcurrent recovery conditions	Charge immediately, or after 60 S automatically	



Transient Overcurrent Protection	Open	Transient Overcurrent Protection	-300A	Can be set	
		Transient Overcurrent Delay	30mS	Can be set	
		Transient Overcurrent Recovery	Charge immediately, or after 60 S automatically		
	Closed	Transient Overcurrent Lock	Continuous secondary overcurrent, exceeding the number of overcurrent locks		
		Overcurrent locking times	5 times		
		Transient lockout	Connect charger		
Output short circuit	Open	Short circuit protection current and delay	Write program (Note: Cannot be set)		
		Recovery of short circuit protection	Charge immediately, or after 60 S automatically		
	Open	Short circuit protection lock	Continuous output short circuit, over-current lock times		
		Short circuit locking times	5 times		
		Short circuit lock release	Connect charger		
Effective discharge current	Discharge into current		-500mA		
	Discharge withdrawal current		-400mA		
Core equalization function	Open	Standby balance	Uncharged/discharge state open equilibrium		
		Standby equalization time	10 hours	Can be set	
	On voltage condition	Charge Balance	Open equalization in charging state and floating state		
		Balanced on voltage	3400mV	Can be set	
		Equilibrium Open Pressure	30mV		
	Equilibrium end differential pressure	20mV			
	Open	Equilibrium temperature limits	Close the temperature range evenly according to the (ambient alarm temperature)		
		Equilibrium High Temperature Ban	50℃	Can be set	
Equilibrium cryogenic prohibition		0℃			



Core Failure Alarm	Open	Failure Pressure Differential	500mV	Can be set
		Core recovery pressure differential	300mV	
Battery capacity setting	Battery rated capacity		200Ah	5Ah~300Ah
	Battery residual capacity		Estimation of core voltage	Can be set
	Accumulated cycle capacity		80%	Number of cycles (Set)
	Open	Residual capacity alarm	15%	
	Open	Residual capacity protection	5%	Turn off output
Precharge function	2000ms	0~5000ms	BMS boot up precharge function	
BMS Power Management	Open	Maximum standby time	48h (Charger is not present and no effective discharge current)	
Low temperature heating of core	Open	Low temperature heating of core	0°C	Can be set
		Core heating recovery	10°C	
		Heating on logic	The charger is on line and the temperature of the cell reaches the opening condition. Turn on and heat up.No heating in standby state and discharge state	
External switches	Open	BMS in standby state can operate external switch off and turn on BMS.		
LCD screen	Open	Simple monitoring software, can view the core,temperature, current and other data.		
Manual charging activation	Open	1 point	After undervoltage protection BMS shut down,manually press the button to clear the undervoltage protection Forced output	Can be set



Compensation impedance	Compensation point 1	0m Ω	9	Can be set
	Compensation point 2	0m Ω	13	

6.2. Basic mode of work

6.2.1. charging mode

When the BMS detects that the charger is connected and the external charging voltage is greater than the internal battery voltage by more than 0.5V, when the charging current reaches the effective charging current, it enters the charging mode.

6.2.2. discharge mode

BMS into discharge mode when the load connection is detected and the discharge current reaches the effective discharge current.

6.2.3. standby mode

When the above two modes are not satisfied, enter standby mode.

6.2.4. shutdown mode

Normal standby for 48 hours, battery triggers under-voltage protection, key-press shutdown or external switch shutdown, BMS enters shutdown mode.

Wake-up conditions for shutdown mode: 1. Charge activation; 2. 48V voltage activation; 3. Press the key to turn on; 4. External switch.

6.3. LED light indication instructions

6.3.1. LED lamp sequence

1 operational light ,1 alarm light ,4 capacity indicator lights



6.3.2. Capacity indication



Status		Status				Discharge			
Capacity indicator		L4 ●	L3 ●	L2 ●	L1 ●	L4 ●	L3 ●	L2 ●	L1 ●
The remaining capacity	0~25%	OFF	OFF	OFF	Flash	OFF	OFF	OFF	Solid Green
	25~50%	OFF	OFF	Flash	Solid Green	OFF	OFF	Solid Green	Solid Green
	50~75%	OFF	Flash	Solid Green	Solid Green	OFF	Solid Green	Solid Green	Solid Green
	≥75%	Flash	Solid Green	Solid Green	Solid Green	Solid Green	Solid Green	Solid Green	Solid Green
Running indicator light ●		Solid Green				Flash			

6.3.3.Light Blink explanation

Flash Mode	ON	OFF
Flash 1	0.25s	3.75s
Flash 2	0.5s	0.5s
Flash 3	0.5s	1.5s

6.3.4.State indication

System state	Running state	RUN	ALM	SOC				Note
		●	●	●	●	●	●	
Shutdown	Sleep	OFF	OFF	OFF	OFF	OFF	OFF	OFF
Standby	Normal	Flash1	OFF	OFF	OFF	OFF	OFF	Standby status
Charge	Normal	Solid Green	OFF	According to battery indicator				Highest LED flash 2
	Alarm	Solid Green	Flash2	According to battery indicator				Highest LED flash 2
	overvoltage protection	Flash1	OFF	OFF	OFF	OFF	OFF	
	Temperature ,overcurrent protection	Flash1	Flash1	OFF	OFF	OFF	OFF	
Discharge	Normal	Flash3	OFF	According to battery indicator				According to battery indicator
	Alarm	Flash3	Flash3					
	Temperature ,overcurrent , short circuit protection	OFF	Solid Green	OFF	OFF	OFF	OFF	Stop discharging, forced dormancy without action after 48h when the mains is offline
	Under-voltage protection	OFF	OFF	OFF	OFF	OFF	OFF	Stopping Discharge



7. Functional description

7.1. Standby state

BMS the correct connection on the power, in no overvoltage, undervoltage, overcurrent, short circuit, over temperature, under temperature and other protection state, press the reset button to boot, BMS in standby state.

BMS standby state, the running lamp flashes, and the battery can be charged and discharged.

7.2. Over-protection and rehabilitation

7.2.1. Monomer overcharge protection and recovery

If any section of the battery core is higher than the set value of the monomer overcharge protection, the BMS enters the overcharge protection state, and the charging equipment can not charge the battery.

After the monomer overvoltage protection, when the maximum monomer voltage drops below the monomer overcharge recovery value and the SOC is below 96%, the overcharge protection state is relieved. can also discharge release.

7.2.2. Total pressure overcharge protection and recovery

If the battery voltage is higher than the set value of the total voltage overcharge protection, the BMS enters the overcharge protection state, and the charging equipment can not charge the battery. If the total voltage drops below the recovery value and SOC below 96%, the overcharge protection is relieved. It can also be released Except.

7.3. Protection and rehabilitation

7.3.1. Protection and restoration of monomers

If any section of the battery core is lower than the set value of the monomer over-discharge protection, the BMS enters the over-discharge protection state, and the load can not discharge the battery. Hold 1 minute communication after BMS shutdown.

After over-discharge protection occurs, charging the battery pack can release the over-discharge protection state. or press the reset button, BMS will boot to re- detect whether the battery pack voltage reaches the recovery value.

Note: After the BMS discharges under-voltage protection, it is shut down, and the button is activated or the charging is activated. The BMS keeps the output voltage for 1 minute for the inverter to detect the battery voltage, so it is not allowed to discharge within 1 minute.

7.3.2. Total pressure protection and recovery

When the battery voltage is lower than the total voltage over-discharge protection set value, the BMS enters the over-discharge protection state, and the load can not discharge the battery. Hold 1 minute communication after BMS shutdown.



After over-discharge protection occurs, charging the battery pack can release the over-discharge protection state. or press the reset button, BMS will boot to re-detect whether the battery pack voltage reaches the recovery value.

Note: After the BMS discharges under-voltage protection, it is shut down, and the button is activated or the charging is activated. The BMS keeps the output voltage for 1 minute for the inverter to detect the battery voltage, so it is not allowed to discharge within 1 minute.

7.4. Charging overcurrent protection and recovery

Charging overcurrent protection can be triggered when there is no charging current limiting function. when the charging current exceeds the charging overcurrent protection setting value and reaches the delay time. BMS access charging overcurrent protection, charging equipment can not charge the battery. After charging overcurrent protection occurs, the BMS automatically delays recovery and re-detects the external charger current. discharge can also remove the charging overcurrent protection.

7.5. Discharge overcurrent protection and recovery

When the discharge current exceeds the discharge overcurrent protection setting value and reaches the delay time. BMS into the discharge overcurrent protection, the load can not charge the battery.

After the discharge overcurrent protection occurs, the BMS automatically delays recovery and re-detects the external load current. charging can also release the discharge overcurrent protection.

Discharge over-current protection has two-stage protection to achieve transient over-current protection and discharge over-current protection recovery. Transient protection occurs when the number of times the condition will be locked, recovery must be turned off in the boot or charge release.

7.6. Temperature protection and recovery

BMS there are 6 temperature detection ports, the implementation of monitoring temperature changes to achieve protection measures.

7.6.1. Charge/discharge high temperature protection and recovery

When charging and discharging state , 4 cores NTC arbitrarily one higher than the high temperature protection set value, BMS into the high temperature protection. BMS stop charging or discharging.

If the temperature of the core is lower than the high temperature recovery value, the charge or discharge BMS resume.

7.6.2. Charge/discharge low temperature protection and recovery

When charging and discharging state , 4 cores NTC randomly one lower than the low temperature protection set value, BMS into the low temperature protection. BMS stop charging or discharging.

If the core temperature is higher than the low temperature recovery value, the



charge or discharge BMS resume.

7.6.3. Ambient temperature protection, power temperature protection

When the NTC detects that the ambient temperature is higher than the ambient high temperature setting value, the BMS enters the ambient high temperature protection. The BMS stops charging and discharging.

When NTC detects that the power temperature is higher than the power protection setting value, the BMS enters the power high temperature protection. The BMS stops charging and discharging.

7.7. Balanced function

BMS should have standby and charge equalization function, the system adopts energy consumption type equalization circuit, the equalization open voltage software is adjustable, the equalization open condition any section is higher than the equalization open voltage and the pressure difference reaches the condition together.

When stop charging or the core pressure difference is less than the set value.

7.8. Turn on and off

Serial number	Function	Definition
1	Boot/boot	BMS in hibernation, press the reset button, the BMS is activated, After the LED indicator lights shine in turn, turn to normal working state.
2	Shutdown / Sleep	BMS in standby or discharge state, press this key, after 6 s, the BMS is dormant, and the LED indicator lights shine in turn, and turn to sleep state. Sleep after BMS no power consumption.
3	External switches	External switch can control BMS switch machine, external switch priority

7.9. Storage functions

Storage content includes: protection and alarm and its category, protection and alarm recovery time, single battery voltage, total battery voltage, charge/discharge capacity, charge/discharge current, temperature, etc.

It records in year/month/day/hour/minute/second, and can also be set to record the information content within a certain period of time.

The amount of information storage is not less than 300.

The historical data can be read through the host computer and saved as an excel file to the computer.

8. Dimensional mapping

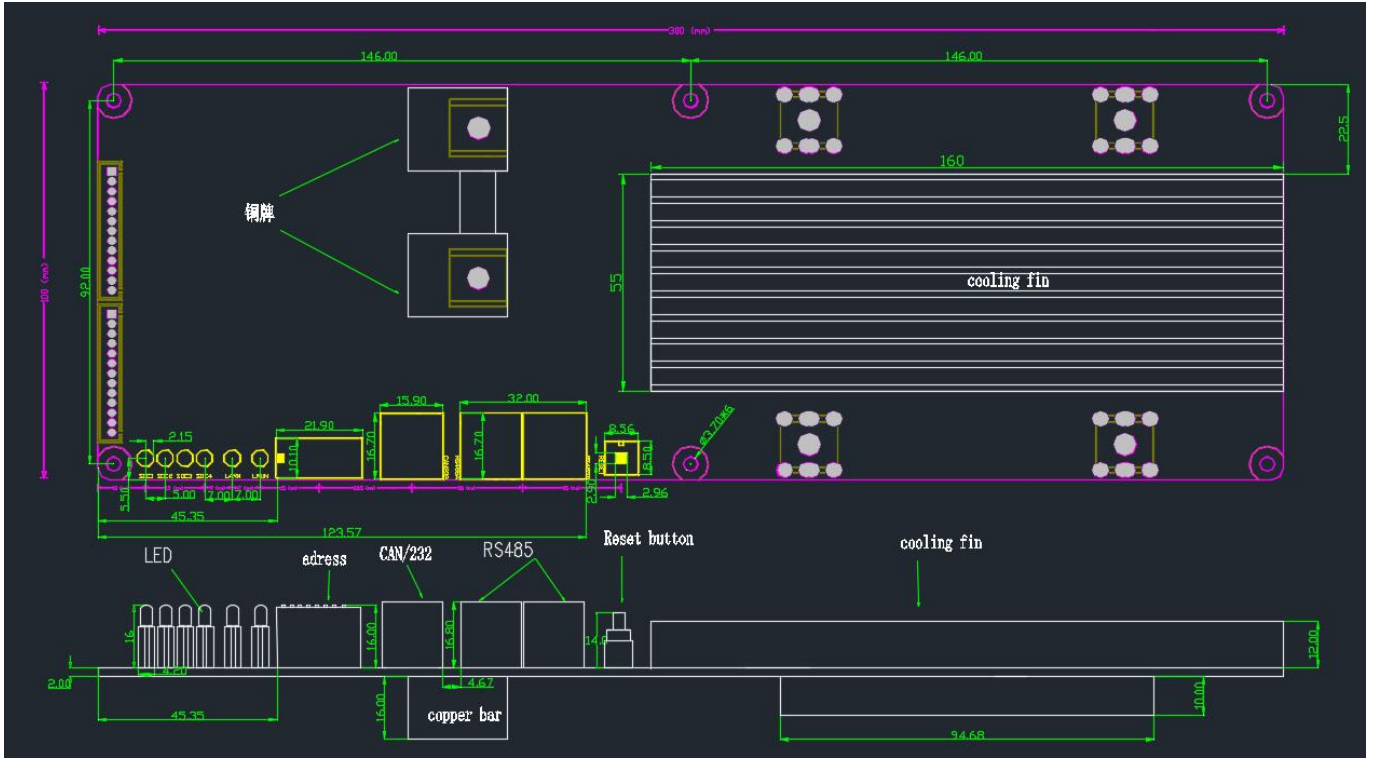

9. Reference diagram and connection instructions

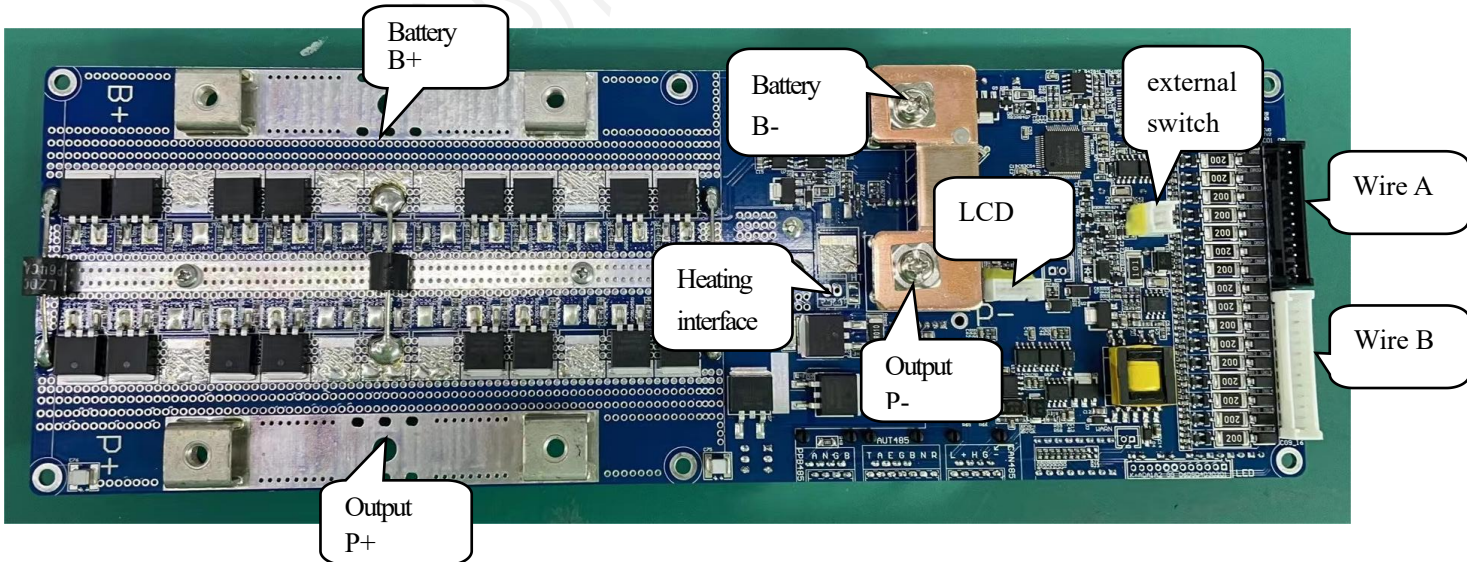

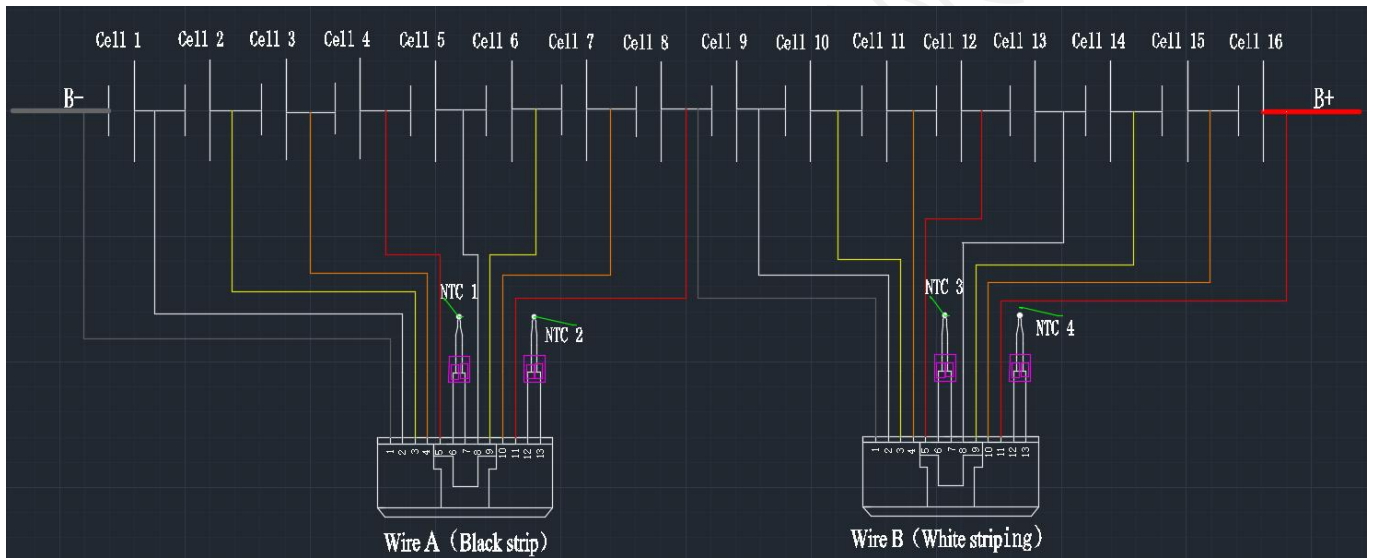
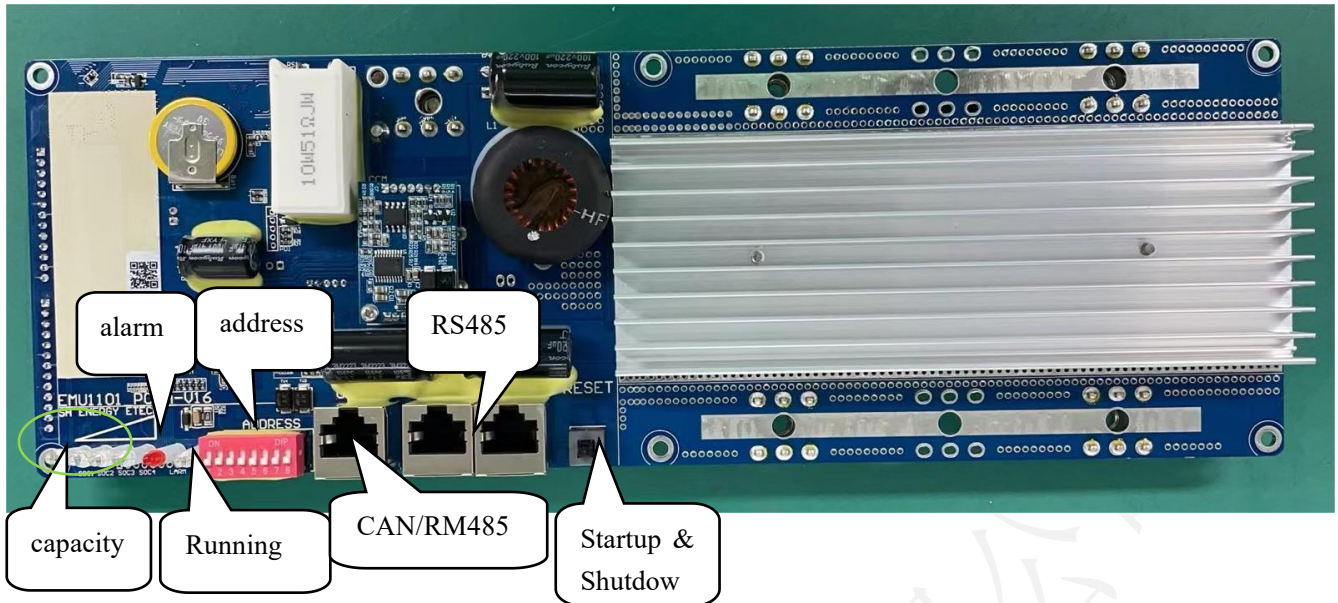

Note: There may be some differences between the actual product and the physical drawing of the above products.

9. 1. Wiring definition

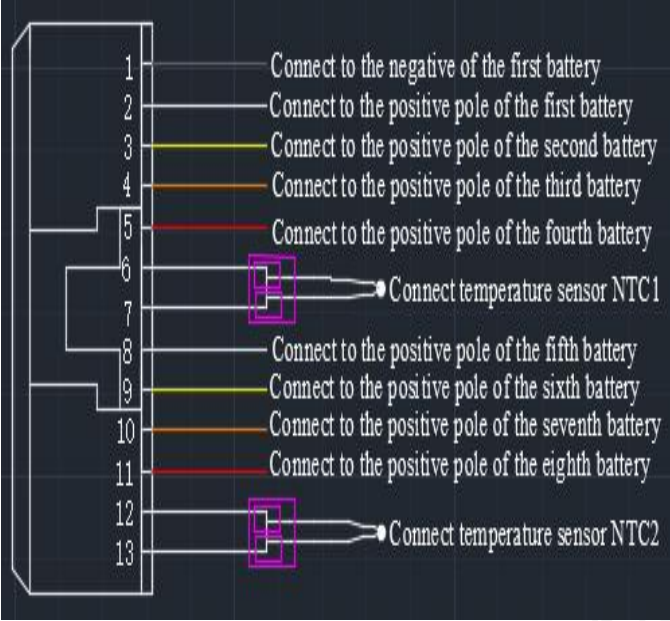
Wire A (Black strip)		
 <p>1 Connect to the negative of the first battery 2 Connect to the positive pole of the first battery 3 Connect to the positive pole of the second battery 4 Connect to the positive pole of the third battery 5 Connect to the positive pole of the fourth battery 6 Connect temperature sensor NTC1 7 8 Connect to the positive pole of the fifth battery 9 Connect to the positive pole of the sixth battery 10 Connect to the positive pole of the seventh battery 11 Connect to the positive pole of the eighth battery 12 Connect temperature sensor NTC2 13</p>	CELL1-	Connect to the negative of the first battery
	CELL1+	Connect to the positive pole of the first battery
	CELL2+	Connect to the positive pole of the second battery
	CELL3+	Connect to the positive pole of the third battery
	CELL4+	Connect to the positive pole of the fourth battery
	NTC1+	Connect temperature sensor NTC1
	NTC1-	Connect temperature sensor NTC1
	CELL5+	Connect to the positive pole of the fifth battery
	CELL6+	Connect to the positive pole of the sixth battery
	CELL7+	Connect to the positive pole of the seventh battery
	CELL8+	Connect to the positive pole of the eighth battery
	NTC2+	Connect temperature sensor NTC2
	NTC2-	Connect temperature sensor NTC2

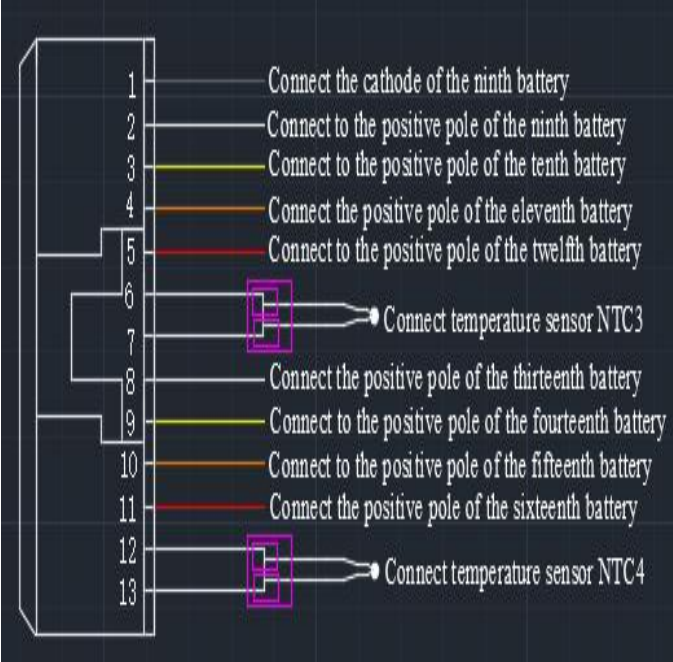
Wire B (White strip)		
	CELL9-	Connect the cathode of the ninth battery
	CELL9+	Connect to the positive pole of the ninth battery
	CELL10+	Connect to the positive pole of the tenth battery
	CELL11+	Connect the positive pole of the eleventh battery
	CELL12+	Connect to the positive pole of the twelfth battery
	NTC3+	Connect temperature sensor NTC3
	NTC3-	Connect temperature sensor NTC3
	CELL13+	Connect the positive pole of the thirteenth battery
	CELL14+	Connect to the positive pole of the fourteenth battery
	CELL15+	Connect to the positive pole of the fifteenth battery
	CELL16+	Connect the positive pole of the sixteenth battery
	NTC4+	Connect temperature sensor NTC4
	NTC4-	Connect temperature sensor NTC4

Note: CELL8+ and CELL9- are connected to the positive pole of the 8th cell and the negative pole of the 9th cell to provide cell sampling accuracy; CELL15+ is the B+ terminal of the cell.

9.2. Order of up and down

1) Assembly sequence: Connect the motherboard B- first, connect wiring harness A and Wiring harness B in turn, connect wiring harness B+ in the motherboard, and finally connect wiring P+ and P- to charger or load (Note: After the motherboard is connected to the line, it is turned off, press the reset button to turn on or close the external switch, charging can also activate the BMS)

2) Dismantling sequence: Disconnect charger or load first (Note: Press the 6S reset button or disconnect the external switch, the circulation light will turn off once and shut down), then disconnect B+, wire harness B, wire harness A successively, and finally Disconnect B-.

3) Input and output

When Charging: the positive pole of the charger is connected to the "P+" of the protection plate, and the negative pole of the charger is connected to the "P-" of the protection plate.

When Discharging: The positive pole of the load is connected to the "P+" of the protection plate, and the negative pole of the load is connected to the "P-" of the protection plate.

10. Communications

10.1. CAN communication and RM485 communication

BMS have battery pack upload CAN communication function, **Baud rate 500K**. CAN communication interface adopts 8P8C network interface. You can communicate with the inverter or CAN TEST via CAN interface. When the battery pack is connected, By RS485 communication sets, The data, status and information of battery pack are uploaded and PCS. by CAN communication.

BMS have battery pack upload RM485 communication function, **Baud rate 9600**. RM485 communication interface adopts 8P8C network interface. When the battery pack is connected, By RS485 communication sets, The data, status and information of battery pack are uploaded and PCS. by RM485 communication.

CAN and RM485 communication interface definition:

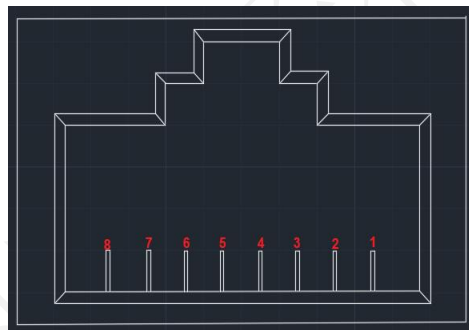

PIN	Definitions
1、8	RS485-B
2、7	RS485-A
4	CAN-H
5	CAN-L
3、6	GND

10.2. RS485 communications

BMS RS485 communication with battery packs, **baud rate 19200 bps**. RS485 communication interface adopts 8 P8C network interface.

RS485 communication interface definition:

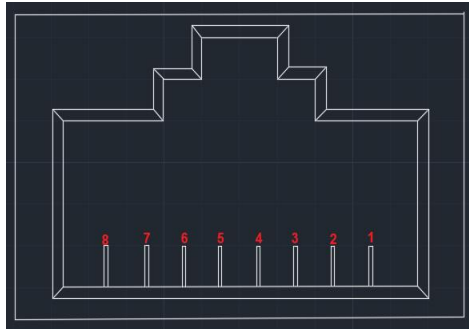

PIN	Definitions
1、8	RS485-B
2、7	RS485-A
3、6	GND
4、5	Internal communication

10.3. Parallel communication

RS485 interface is used as parallel communication interface and CAN interface as upper communication interface. the terminal device can read the sum of battery data of all parallel PACK through the CAN interface. RS485 interface connection is shown in the following figure:

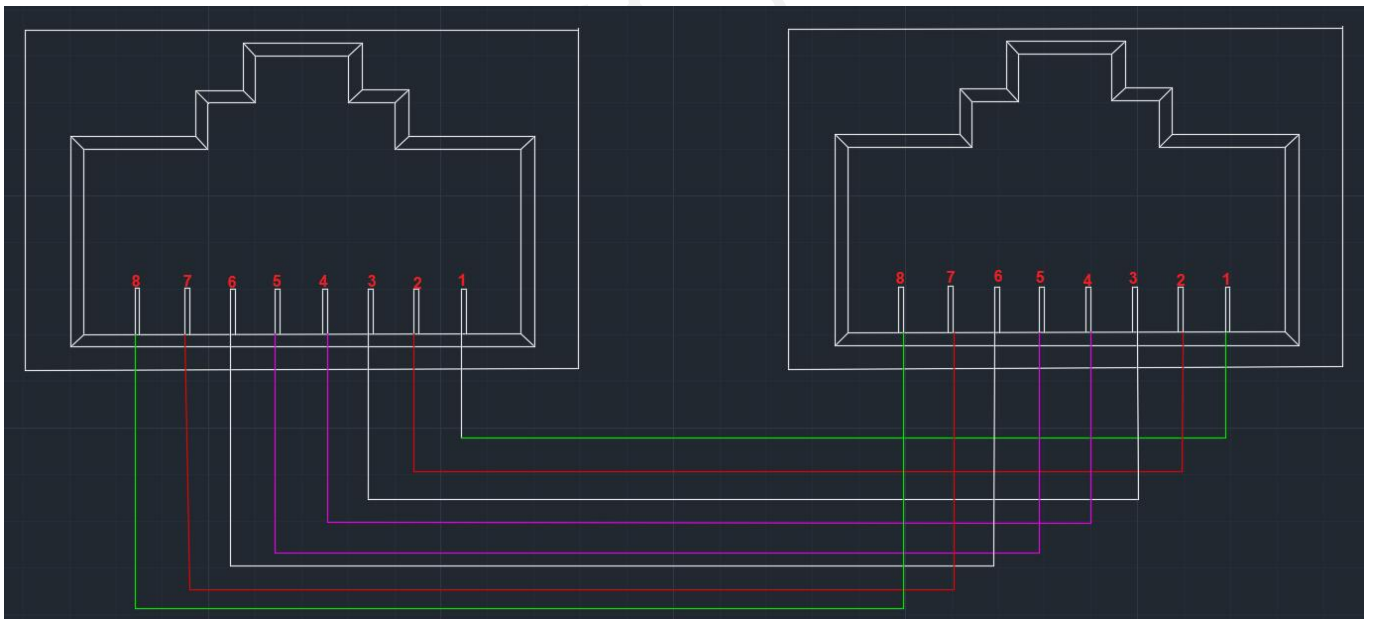

10.4. Dial code address selection

Definition of parallel machine dialing switch: multi-machine communication when the battery Pack is in parallel. The dial switch is used to distinguish the different PACK addresses. The hardware address can be set by the dial switch on the board.

The code dialing switches bit1 to bit8 define: bit1 to bit4 is used to set the address and bit5 to bit8 is used to set the number of slave machines.

Host setting: bit1 to bit4 is 0, host address is fixed at 0, bit5 to bit8 is set according to the number of parallel slave machines. (See Table 2)

From machine: bit1 to bit4 is set according to device order, from machine address range 1 to 15. Bit5 through bit8 is fixed at 0. (See table 1)

Address settings: Dial code switches are defined in the following table

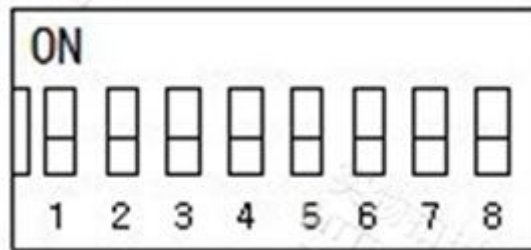

From the machine address(See Table 1)

address	Dial the code switch position				Note
	#1	#2	#3	#4	
1	ON	OFF	OFF	OFF	Pack1
2	OFF	ON	OFF	OFF	Pack2
3	ON	ON	OFF	OFF	Pack3
4	OFF	OFF	ON	OFF	Pack4
5	ON	OFF	ON	OFF	Pack5
6	OFF	ON	ON	OFF	Pack6
7	ON	ON	ON	OFF	Pack7
8	OFF	OFF	OFF	ON	Pack8
9	ON	OFF	OFF	ON	Pack9
10	OFF	ON	OFF	ON	Pack10
11	ON	ON	OFF	ON	Pack11
12	OFF	OFF	ON	ON	Pack12
13	ON	OFF	ON	ON	Pack13
14	OFF	ON	ON	ON	Pack14
15	ON	ON	ON	ON	Pack15

Host address(See Table 2)

Number of	Dial the code switch position	Note



comp uters					
	#5	#6	#7	#8	
1	OFF	OFF	OFF	OFF	Stand-alone use
2	ON	OFF	OFF	OFF	2 units in parallel
3	OFF	ON	OFF	OFF	3 units in parallel
4	ON	ON	OFF	OFF	4 units in parallel
5	OFF	OFF	ON	OFF	5 units in parallel
6	ON	OFF	ON	OFF	6 units in parallel
7	OFF	ON	ON	OFF	7 units in parallel
8	ON	ON	ON	OFF	8 units in parallel
9	OFF	OFF	OFF	ON	9 units in parallel
10	ON	OFF	OFF	ON	10 units in parallel
11	OFF	ON	OFF	ON	11 units in parallel
12	ON	ON	OFF	ON	12 units in parallel
13	OFF	OFF	ON	ON	13 units in parallel
14	ON	OFF	ON	ON	14 units in parallel
15	OFF	ON	ON	ON	15 units in parallel

Example of parallel dial code setting

Number of computers	Dial the code switch position								Note
	#1	#2	#3	#4	#5	#6	#7	#8	
Use single	OFF	OFF	OFF	OFF	OFF	OFF	OFF	OFF	Stand-alone use
Two weaver	OFF	OFF	OFF	OFF	ON	OFF	OFF	OFF	The first host
	ON	OFF	OFF	OFF	OFF	OFF	OFF	OFF	The second slave
Three weaver	OFF	OFF	OFF	OFF	OFF	ON	OFF	OFF	The first host
	ON	OFF	OFF	OFF	OFF	OFF	OFF	OFF	The second slave
	OFF	ON	OFF	OFF	OFF	OFF	OFF	OFF	The third slave
⋮	⋮	⋮	⋮	⋮	⋮	⋮	⋮	⋮	⋮
⋮	⋮	⋮	⋮	⋮	⋮	⋮	⋮	⋮	⋮
16 sets	OFF	OFF	OFF	OFF	ON	ON	ON	ON	The first host
	ON	OFF	OFF	OFF	OFF	OFF	OFF	OFF	The second slave
	OFF	ON	OFF	OFF	OFF	OFF	OFF	OFF	The third slave

weaver	ON	ON	OFF	OFF	OFF	OFF	OFF	OFF	The fourth slave
	OFF	OFF	ON	OFF	OFF	OFF	OFF	OFF	The fifth slave
	ON	OFF	ON	OFF	OFF	OFF	OFF	OFF	The sixth slave
	OFF	ON	ON	OFF	OFF	OFF	OFF	OFF	Seventh slave
	ON	ON	ON	OFF	OFF	OFF	OFF	OFF	Eighth slave
	OFF	OFF	OFF	ON	OFF	OFF	OFF	OFF	The ninth slave
	ON	OFF	OFF	ON	OFF	OFF	OFF	OFF	The tenth slave
	OFF	ON	OFF	ON	OFF	OFF	OFF	OFF	The eleventh slave
	ON	ON	OFF	ON	OFF	OFF	OFF	OFF	Twelfth slave
	OFF	OFF	ON	ON	OFF	OFF	OFF	OFF	The thirteenth slave
	ON	OFF	ON	ON	OFF	OFF	OFF	OFF	Fourteenth slave
	OFF	ON	ON	ON	OFF	OFF	OFF	OFF	Fifteenth slave
	ON	ON	ON	ON	OFF	OFF	OFF	OFF	Sixteenth slave

10.5. Automatic DIP switch mode

The automatic dip connection diagram is as follows:

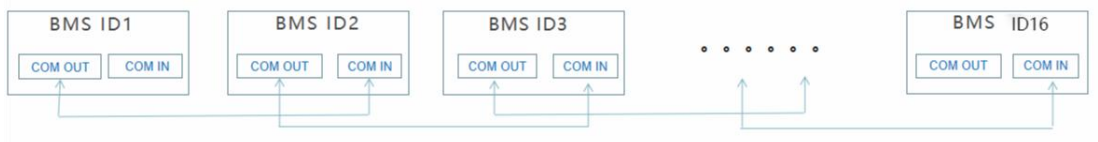

Note: The default limit is 16. If you need special customization, please contact the manufacturer

11. LCD Screen

Please refer to the LCD screen specification for detailed instructions

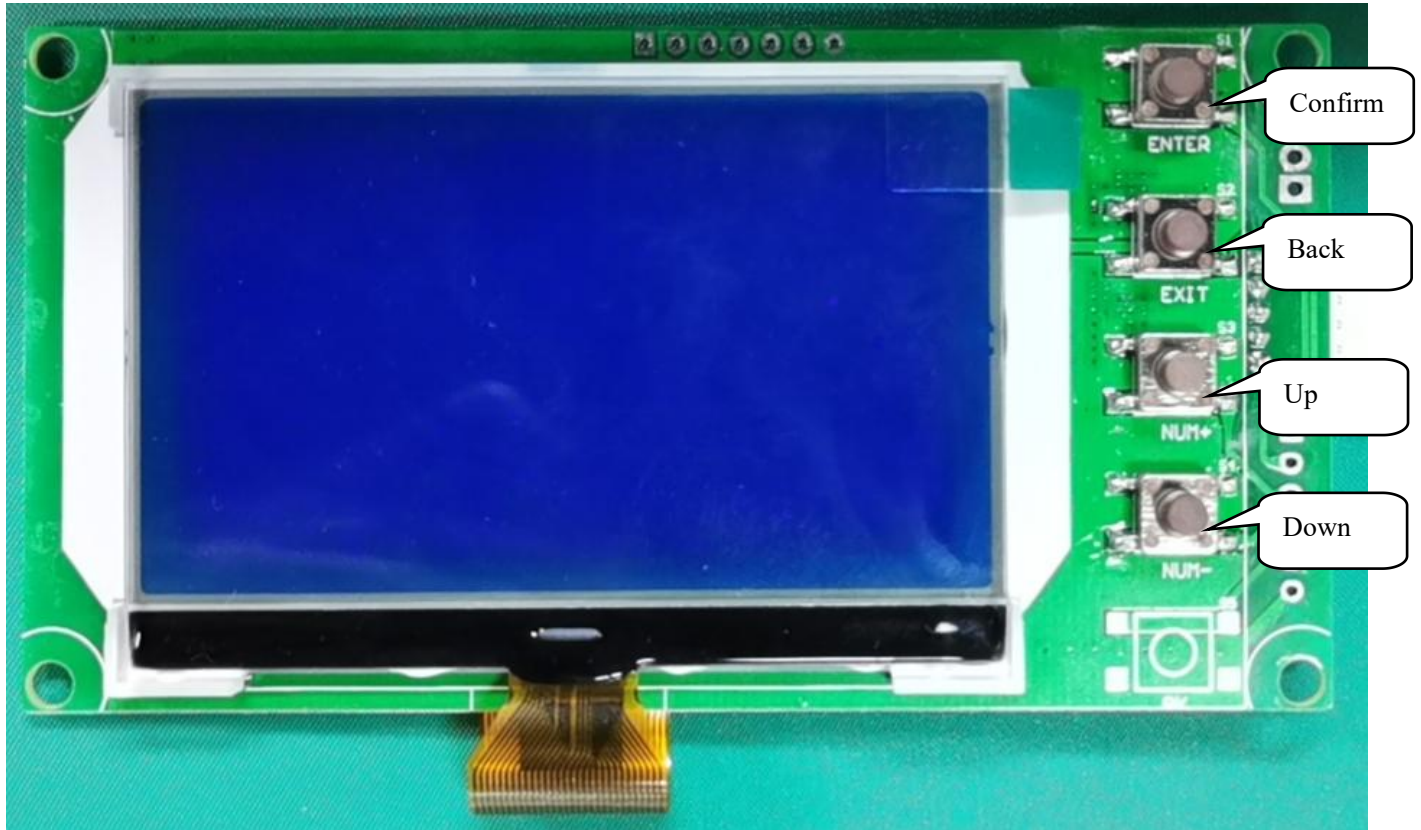

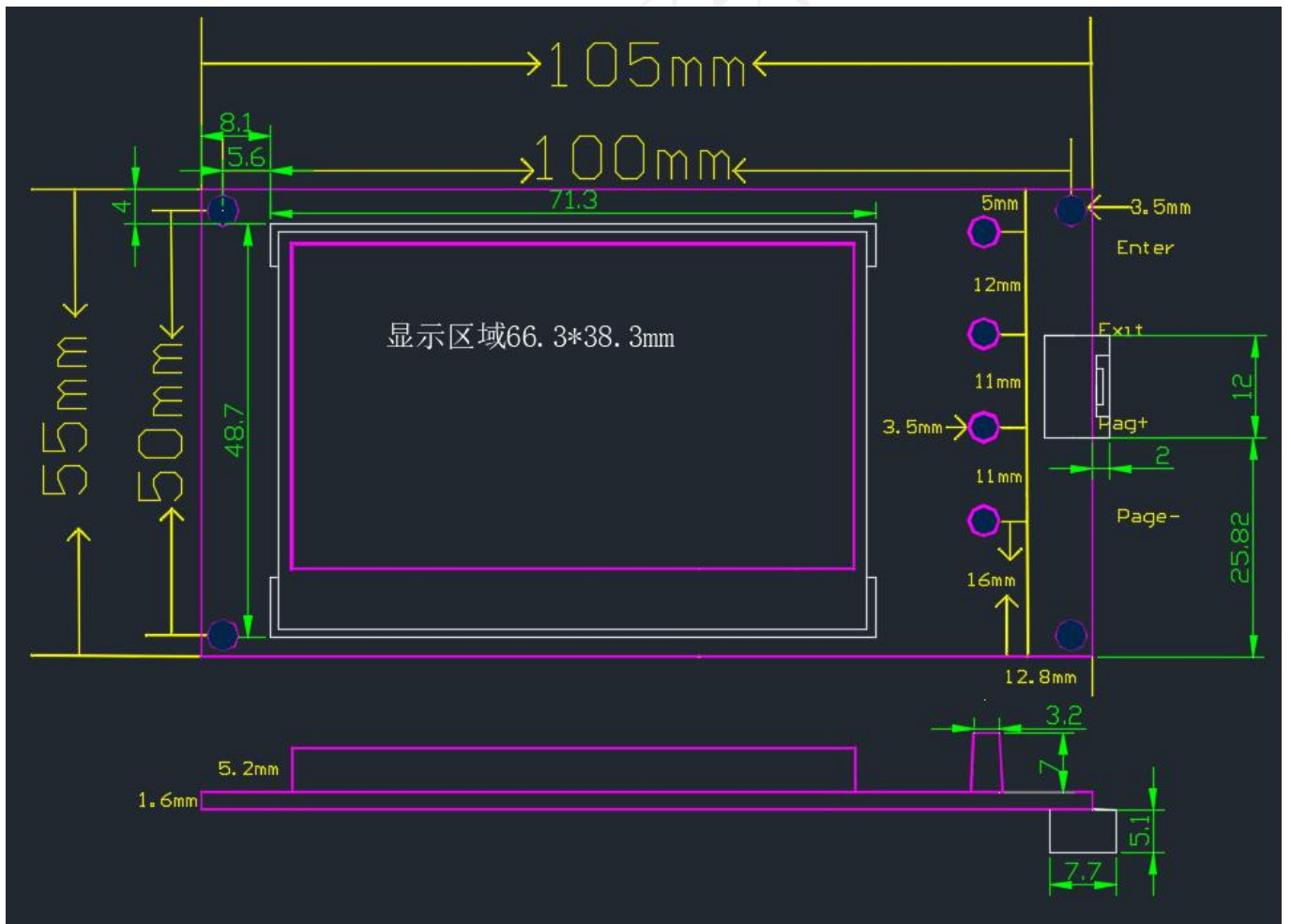
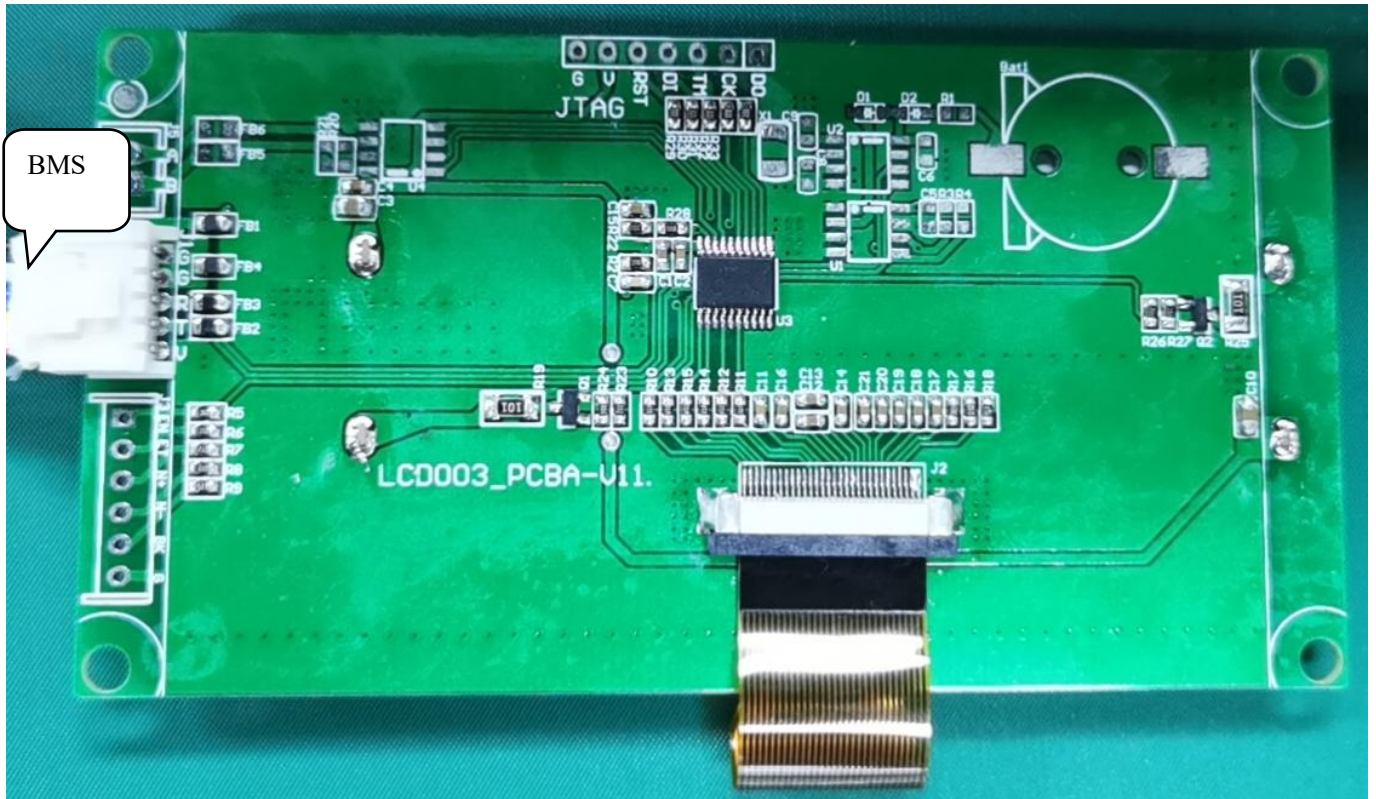



Note: The display screen is shipped according to the actual situation. Our company has three kinds of display screens LCD003 and LCD005.

上海恩阶电子科技有限公司



12. Points for attention

- ❖ Battery management systems can not be used in series.
- ❖ BMS power components withstand voltage 100V.
- ❖ If the battery module is assembled in the form of long wire and long copper bar, it must communicate with the BMS manufacturer for impedance compensation. Otherwise, it will affect the consistency of the cell.
- ❖ The external switch on BMS is prohibited to connect with other equipment. If necessary, please confirm with the technology for docking. Otherwise, BMS will not bear any responsibility for damage.
- ❖ Do not touch the surface of the core directly when assembling, so as not to damage the core. The assembly should be firm and reliable.
- ❖ In use pay attention to lead wire head, soldering iron, solder and so on do not touch the components on the circuit board, otherwise it may damage the circuit board.
- ❖ Use process should pay attention to anti-static, moisture-proof, waterproof and so on.
- ❖ Please follow the design parameters and use conditions during use, must not exceed the value in this specification, otherwise it may damage the protection board.
- ❖ After combining the battery pack and the protection plate, if you find no voltage output or charge, please check the wiring is correct.
- ❖ The final interpretation right is owned by our company.